

Congratulations! We welcome you to the exciting world of motor home travel and camping. You will find it convenient and enjoyable to have all the comforts of home and still enjoy the great outdoors wherever you choose to go.

Your motor home has been carefully designed, engineered and manufactured to provide dependability as well as safety. Before sliding into the driver's seat, take a few minutes to become familiar with operations and features. This manual was prepared to aid you in the proper care and operation of the vehicle and equipment. We urge you to read it completely. In addition, spend some time with the dealer when you take delivery, you will want to learn all you can about your new motor home.

Your new motor home is covered by a factory warranty against defects in material and workmanship. This warranty should be validated at once and returned to the factory by your dealer.

Read and understand all instructions and precautions in this manual before operating your new motor home. Throughout this manual, certain items are labeled NOTE, CAUTION and WARNING. These terms alert you to precautions that can involve risk to your vehicle or to your personal safety. Read and follow them carefully.

NOTE: Indicates a special point of information.

CAUTION

Indicates that a failure to observe can cause damage to vehicle or equipment

WARNING

This symbol is used to alert you to precautions that involve your personal safety as well as vehicle damage. Read and follow them carefully.

OWNER'S NAME
STREET ADDRESS
CITY AND STATE (OR PROVINCE IN CANADA)
MOTOR HOME SERIAL NUMBER
VEHICLE CHASSIS IDENTIFICATION NO. (VIN)
DATE OF DELIVERY TO FIRST RETAIL PURCHASER
VEHICLE MILEAGE AT TIME OF DELIVERY
SELLING DEALER NAME AND ADDRESS

TANK CAPACITIES



Chassis Fuel Tank75 gal. (nominal)



LP Gas Tank..... 23 gal.* (28 gal. w.c.)



Fresh Water Tank..... 70 gal.



Water Heater w/Motor Aid Heater 10 gal.



Black Water Holding Tank (Toilet)
 39 Ft. Models..... 48 gal.
 36 Ft. Models..... 45 gal.



Grey Water Holding Tank (Galley, Shower & Lavatory)
 39 Ft. Models..... 58 gal.
 36 Ft. Models..... 67 gal.

*LP Gas tank capacity shown is the usable "full" LP gas capacity, which is 80% of the tank manufacturer's listed water capacity (w.c. shown in parenthesis). An LP tank must have at least 20% of tank volume free to allow for expansion and proper vaporization of the liquid fuel. The tank is also equipped with mandatory safety shut-off equipment that prevents filling above this level.

Chieftain

TABLE OF CONTENTS

INTRODUCTION

About This Manual	0-1
Chassis Operating Guide	0-1
Before Driving	0-1
Owner's InfoCase	0-1
Options and Equipment	0-2
Before Driving	0-2
Service Assistance	0-2
Warranty	0-2
Drinking and Driving	0-2
Reporting Safety Defects	0-2
Vehicle Certification Label	0-4
Exterior Feature Identification	0-5

SECTION 1: SAFETY PRECAUTIONS

General Warnings	1-1
Driving	1-1
Fuel & LP Gas	1-2
LP Gas Leaks	1-3
LP Gas Alarm	1-3
Electrical	1-4
Loading	1-4
Maintenance	1-5
Formaldehyde Warning	1-5
Carbon Monoxide Warning	1-5
Carbon Monoxide Alarm	1-6
Emergency Exit Window	1-6
Fire Extinguisher	1-6
Smoke Alarm	1-7

SECTION 2: DRIVING YOUR MOTOR

HOME

Before Entering	2-1
Before Driving	2-1
Fuel Information	2-2
Fuel Tank Fill	2-2
Fuel Tank Capacity	2-2
Starting and Stopping Engine	2-2
Parking Brakes	2-2
Door Locks and Handles	2-5
"Key One" Lock System	2-5
Entrance Step	2-6
Luggage Compartment Doors	2-6
Seats	2-5
Seat Belts	2-7
Three-Point Lap Shoulder Belt	2-7
Child Restraints	2-8

Power Mirrors	2-9
Sony Rearview Monitor System	2-9
Instrument Panel	2-11, 2-12
Cruise Control	2-13
Comfort Controls	2-13
Heating	2-13
Defrosting	2-14
Ventilation	2-14
Air Conditioning	2-14
Aux. Coach Heater	2-14
Stereo Sound Systems	2-14
Radio Power Switch	2-14
Deluxe Sound System	2-15
Compact Disc Changer	2-15
Auxiliary Start Switch	2-15
Auxiliary Battery Switch	2-16
CB Radio Wiring	2-16
Coach Leveling Systems	2-17
Slideout Room	2-18
Travel Straps	2-18
Extending Room	2-19
Retracting Room	2-19
Emergency Crank-In	2-20

SECTION 3: IN CASE OF DRIVING

EMERGENCY

Hazard Flashers	3-1
Spare Tire	3-1
Tire Changing	
Safety Precautions	3-2
Front Wheel	3-2
Dual Rear Wheels	3-3
Wheel Nuts	3-3
Recovery Towing	3-3
Jump Starting	3-3
Connecting a Battery Charger	3-4
Engine Overheat	3-4

SECTION 4: TRAVELING WITH YOUR MOTOR HOME

Loading the Vehicle	4-1
Front Axle Tire Alignment	4-1
Weighing Your Loaded Vehicle	4-1
Maximum Occupancy	4-2
Roof Loading	4-2
Car or Trailer Towing	4-2
Pre-Travel Checklist	4-3

TABLE OF CONTENTS

Travel Tips	4-3	Water Pump Switch.....	7-2
Severe Weather Information	4-4	Accumulator Tank.....	7-3
Nighttime Driving	4-5	External (City Water) Connection	7-3
Mountain Driving	4-5	Disinfecting Fresh Water Tank	7-4
Campsite Selection	4-6	Water Purifier System	7-5
Leveling	4-6	Shower Hose Vacuum Breaker	7-5
Blocking.....	4-6	Exterior Shower	7-5
Effects of Prolonged Occupancy	4-7	Waste Water System	7-6
Humidity and Condensation	4-7	Dumping Holding Tanks.....	7-6
SECTION 5: LP GAS SYSTEM		Flushing Black Water Tank.....	7-6
LP Gas Supply	5-1	Using On-Site Sewer Hook-Ups.....	7-7
Safe Use of LP Gas System	5-1	Water Drain Valves	7-8
How LP Gas Works	5-1	Holding Tank Capacities.....	7-9
Selecting Fuel Types.....	5-2	Water System Drain Valve	
LP Tank System	5-2	Locations.....	7-9
Refilling Tank	5-3	SECTION 8: APPLIANCES AND	
Air in the LP Gas Tank	5-3	INTERIOR FEATURES	
Traveling with LP Gas	5-3	Refrigerators	8-1 - 8-5
Regulator.....	5-3	Range and Oven.....	8-5
LP Gas Leaks	5-4	Microwave Oven & Range Hood	8-6
Winter Use of LP Gas	5-5	OnePlace Monitor Panel	8-7
SECTION 6: ELECTRICAL SYSTEMS		Tank Level Checking	8-7
110-Volt AC System	6-1	Water Heater	8-8
External Power Cord (Shoreline).....	6-1	By-Pass Valve	8-11
Connecting the Shoreline.....	6-2	Motor Aid Water Heater	8-11
PowerLine Energy Management		LP Gas Furnace.....	8-12
System.....	6-3	Heat Pump.....	8-13
Circuit Breakers	6-3	TrueAir Central Air Conditioner	8-14
Power Converter System	6-3	TV Antenna.....	8-15
Charging Section.....	6-4	Antenna Checklight	8-16
Overload Protector	6-4	TV Signal Amplifier	8-16
Receptacles (Outlets)	6-5	Phone & Cable TV Hook-Up	8-16
Ground Fault Circuit Interrupter		Video Selection System	8-17
(GFCI).....	6-5	Satellite TV System - Optional	8-18
Auxiliary 110-Volt Generator		DC-AC Electrical Voltage Inverter.....	8-18
Operating Instructions.....	6-5	Exterior Entertainment Center	8-18
12-Volt DC System	6-7	Sleeping Facilities	
Chassis (Starting) Battery	6-8	Couch/Bed Conversion.....	8-19
House Battery	6-8	Dinette/Bed Conversion.....	8-19
Solar Charger Panel	6-8	Rest Easy Multi Position Lounge	8-20
Battery Access (Storage).....	6-9	Fresh Water Toilet.....	8-21
Battery Maintenance	6-10	Bath Vents	8-22
Trailer Wiring Connector	6-11	Crank-Out Windows	8-22
SECTION 7: PLUMBING SYSTEMS		Slider Windows.....	8-22
Fresh Water System	7-1	Day/Night Pleated Shades	8-22
Filling Water Tank	7-1	SECTION 9: CARE AND MAINTENANCE	
Fresh Water Tank Capacity	7-1	Roof	9-1
Water Pump.....	7-2	Underbody	9-1

Exterior	9-1
Waxing and Polishing	9-1
Stripes and Decals, care of.....	9-2
Compartment Doors.....	9-2
Interior Maintenance	
Upholstery, Carpeting and	
Draperies	9-2, 9-3
Cabinets	9-3
Vinyl Wallboard	9-3
Tables and Countertops.....	9-4
Stainless Steel Sink	9-4
Bathroom	9-4
Doors and Windows.....	9-4
Vehicle Maintenance	
Chassis Service and Maintenance	9-4
Engine Access.....	9-5
Engine Cooling System	9-6
Tires	9-6
Suspension Alignment and Tire	
Balance.....	9-6
Windshield Washers and Wipers.....	9-7
Lights	9-7
Automotive 12-Volt	
Circuit Breakers	9-7
SECTION 10: STORING YOUR MOTOR	
HOME	
Preparing Vehicle for Storage	10-1
Cold Weather Storage	
(Winterizing).....	10-1, 10-3
RV Antifreeze Winterization	
Systems	10-4
Remove from Storage	10-5

**2002 NEW VEHICLE LIMITED WARRANTY
WINNEBAGO INDUSTRIES, INC.**



WARRANTY COVERAGE TO OWNER

Winnebago Industries, Inc. of Forest City, Iowa warrants each new Winnebago and Itasca motor home to the owner for use in the U.S. and Canada as follows:

WARRANTY PERIOD

The Warranty Period for all coverages begins on the date the vehicle is delivered to the first retail purchaser or first placed in service as a demonstrator or company vehicle.

BASIC COVERAGE

The basic Warranty Period is 12 months or 15,000 miles (24,135 kilometers), on the odometer, whichever occurs first. Winnebago does not authorize any person to create for it any other obligations or liability in connection with this vehicle. ANY IMPLIED WARRANTY OF MERCHANTABILITY OR FITNESS FOR A PARTICULAR PURPOSE APPLICABLE TO THIS VEHICLE IS LIMITED IN DURATION TO THE DURATION OF THIS WRITTEN WARRANTY AS HEREINBEFORE OR HEREINAFTER PROVIDED. THE PERFORMANCE OF REPAIRS IS THE EXCLUSIVE REMEDY UNDER THIS WRITTEN WARRANTY OR ANY IMPLIED WARRANTY. WINNEBAGO SHALL NOT BE LIABLE FOR INCIDENTAL OR CONSEQUENTIAL DAMAGES FOR LOSS OF TIME, INCONVENIENCE, OR OTHER CONSEQUENTIAL DAMAGE INCLUDING EXPENSE FOR GASOLINE, TELEPHONE, TRAVEL, LODGING, LOSS OR DAMAGE TO PERSONAL PROPERTY, OR LOSS OF REVENUE RESULTING FROM BREACH OF THIS WRITTEN WARRANTY OR ANY IMPLIED WARRANTY. Some states do not allow limitations on how long an implied warranty will last or the exclusion or limitation of incidental or consequential damages, so the above limitations or exclusions may not apply to you.

ITEMS NOT SUBJECT TO WARRANTY COVERAGE.

- Chassis*
- Wheels*
- Tires*
- Service Items, such as Windshield Wiper Blades, Lubricants, Fluids & Filters
- Adjustments

*These items are covered under the manufacturer's individual warranty.

This warranty gives you specific legal rights and you may also have other rights which vary from state to state.

Also, this warranty shall not apply to failures, damage or malfunctions resulting from normal wear, misuse, abuse, negligence, alteration, accident, fire, improper repair of the vehicle or failure to follow recommended maintenance requirements.

36 MONTHS/36,000 MILE STRUCTURAL WARRANTY

At the expiration of the Basic Coverage and for the remainder of the period of 36 months or 36,000 miles (57,924 kilometers), on the odometer, whichever occurs first, Winnebago warrants the following:

1. Body Thermo-Panel® Lamination of the sidewalls and backwall against delamination. Body Thermo-Panel® Lamination is the bonding of the exterior skin and the interior paneling to an insulating core material. Delamination (separation of layers) caused by other factors such as physical damage or failure to properly maintain sealants is not covered by this warranty.
2. The slide-out room assembly for defects in material or workmanship.
3. Structural defects of the subfloor and floor. Floor lamination failure and lamination failure of the subfloor panels and risers are covered by the structural warranty.

Winnebago Industries, Inc.
P.O. Box 152
Forest City, Iowa 50436

ATTENTION: WARRANTY DEPT.

WINNEBAGO'S RESPONSIBILITY

Any part of the vehicle subject to warranty which is found to be defective in material or workmanship, will be repaired or replaced at Winnebago Industries' option upon notice of the defect without charge to the customer for parts or labor. While any Winnebago or Itasca motor home dealer can perform warranty service, we recommend you return to the dealership that sold you your vehicle. If you are touring or have moved, contact any Winnebago or Itasca motor home dealer in the United States or Canada for warranty service.

CUSTOMER RESPONSIBILITY WHEN REPAIRS ARE NEEDED

If a part of the system covered by this warranty fails to function or requires service during the warranty period:

1. Promptly take the vehicle to the selling dealer for repair or inspection.
2. Written notice of defects must be given to the selling dealer or manufacturer no later than 10 days after the expiration of the warranty.
3. If the dealer is incapable of making the repairs, request that he contact Winnebago Industries, Inc.
4. If, after the above steps are completed and the repair is not made, the customer should contact Winnebago Industries, Inc., P.O. Box 152, Forest City, Iowa 50436, Attention: Owner Relations Department (800-537-1885) and furnish the following information:
 - The complete serial number of the vehicle
 - Date of retail purchase
 - Selling dealer's name
 - Nature of the service problem, and a brief explanation of the steps or service the dealer has performed, and the results obtained. The customer may be directed to another dealer or service center for repairs to be completed, if such a dealer or service center is better able to complete the repair.

Winnebago may, at its option, request the vehicle be returned to Forest City, Iowa for repair. If the customer refuses to allow repairs to be performed at the Forest City, Iowa facility, the warranty on that repair will be voided.

5. If after the above steps are completed and the repairs are not satisfactory, the customer may contact the Service Administration Manager of Winnebago Industries, and request a customer relations board meeting to resolve the problem. This action, however, is not mandatory.
6. Certain components are covered beyond the 12 months/15,000 miles basic warranty coverage by the individual manufacturer's warranty. Please refer to the component's information supplied in the owner's information InfoCase for any additional warranty coverage after the basic warranty has expired.

PART NO. 701677-J5-000 4-01

DEALER'S REPRESENTATIONS EXCLUDED

Winnebago Industries, Inc. does not undertake the responsibility to any purchaser of its products for any undertaking, representation, or warranty made by dealers selling its product beyond those herein expressed.

INSTALLATION NOT COVERED

Winnebago Industries, Inc. cannot, however, and does not accept any responsibility in connection with any of its motor homes for additional equipment or accessories installed at any dealership or other place of business, or by any other party other than Winnebago Industries, Inc. Such installation of equipment or accessories by any other party will not be covered by the terms of this warranty.

CARE AND MAINTENANCE

It is the owner's responsibility to perform the care, maintenance and proper load distribution described in the owner's manual which accompanies your motor home. Any damage which results to your vehicle as a result of your failure to perform such duties, is not covered.

Damage to appearance items such as fiberglass, metal, paint, fabrics and trim, may occur during manufacturing or transporting. Normally, any factory defect or damage is corrected at the factory. In addition, dealers are obligated to inspect each vehicle upon delivery to them and prior to delivery to you. You should also immediately inspect appearance items and advise your selling dealer of any discrepancies. Damage and normal deterioration due to use and exposure is not covered by this warranty.

CHANGES IN DESIGN

Winnebago Industries, Inc. reserves the right to make changes in design and changes or improvements upon its products without imposing any obligation upon itself to install the same upon its products theretofore manufactured.

NEW YORK:

If your motor home has been repaired three or more times for the same nonconformity, defect, or condition, or if your motor home has been out of service by reason of repair for twenty-one days, Section 198-a of the General Business Law of the State of New York requires you to provide written notice by certified mail, return receipt requested, to Winnebago or its authorized dealer before making any claim under that section of the law. If you do have problems with your motor home, you should provide written notice to Winnebago at the following address:

Winnebago Industries, Inc.
P.O. Box 152
Forest City, Iowa 50436
Atten: Owner Relations

IMPORTANT: THIS NOTICE IS TO BE USED ONLY FOR RECORD KEEPING BY WINNEBAGO INDUSTRIES
The completed form does not constitute an actual change of ownership.

-----CUT HERE-----

NOTICE OF SECOND OWNER

ORIGINAL OWNER	NAME	
	ADDRESS	
NEW OWNER	NAME	
	ADDRESS	ZIP CODE
WINNEBAGO IDENTIFICATION NUMBER	VEHICLE MILEAGE	DATE
CHASSIS IDENTIFICATION	NEW OWNER SIGNATURE	



Congratulations on the purchase of your new Chieftain motor home, which has been carefully designed, engineered and quality built by Winnebago Industries, Inc.



ABOUT THIS MANUAL

Please read this operator's manual completely to understand how everything in your coach works before taking it on its "maiden voyage."

This manual is a guide to safe operation of the features, equipment and controls in this coach. Some equipment, such as the vehicle chassis and certain electronic systems or appliances, have their own comprehensive, manufacturer supplied manuals or information sheets which describe operation of these products in great detail. This manual will refer you to the manufacturer's information included in your Owner *INFOCASE* whenever necessary.

SUBJECT ICONS - To make it easier for you to find information you're looking for, we have placed convenient, pictorial symbols called "icons" beside many of the subject headings in this manual. The icons correspond to the subject matter of the section. These icons were designed similar to the familiar international symbols which identify public facilities such as restrooms and handicap access. There are several examples of icons on this page.

PAGE ICONS - The icons at the upper corners of each page correspond to the primary content of each main section of the manual, such as LP Gas, Electrical, Plumbing, etc. This means you can flip through the manual either forward or backward and know exactly which main section you are looking for just by watching the icons at the top of the page. This means less paging back and forth.

We also urge you to read the complete Chassis Operating Guide provided by the chassis maker and all other operating information provided by our equipment suppliers and manufacturers. This is contained in your Owner *INFOCASE*TM.

This manual should be kept in the vehicle at all times for personal reference. The operator's manual, *INFOCASE* and chassis operating guide are to be considered permanent components of this vehicle. They should remain in the vehicle when sold to provide the next owner with important safety, operating and maintenance information.

NOTE: The descriptions, illustrations, and specifications in this manual were correct at the time of printing. We reserve the right to change specifications or design without notice, and without incurring obligation to install the same on products previously manufactured.



CHASSIS OPERATING GUIDE

Throughout this manual, frequent reference is made to the vehicle chassis operating guide. The chassis guide is the operator's manual provided by the manufacturer of the chassis on which this motor home is built (i.e., Workhorse). Consult the chassis guide for operating safety and maintenance instructions pertaining to the chassis section of the motor home.

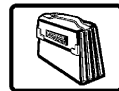

OWNER'S INFOCASE

Your Owner's InfoCase contains information supplied by manufacturers of individual appliances and equipment installed in your motor home.

Consult this information regarding the operation and care of appliances, accessories and special equipment.



OPTIONS AND EQUIPMENT

This model is available in several sizes and floorplans, so accessories and components may differ slightly between models. Some equipment described in this manual may not apply to your coach.



BEFORE DRIVING

Before sitting in the driver’s seat, always check around your vehicle to be sure you have proper clearance for maneuvering. If necessary, have a passenger help guide you out of a difficult parking space.

Although your coach features automotive conveniences like power steering and power brakes, driving a motor home is different from driving a car. A motor home is larger and heavier than an automobile, so it requires more stopping and passing distance, and more parking and maneuvering space than a car does.

Always be mindful of the size of your motor home. The added height of roof air conditioners, TV antennas or luggage boxes may cause clearance problems around some tunnels, canopies and hanging signs. Know the height of your unit so you can observe posted clearance limits. Also, remember that some bridges, old ones in particular, may not support the weight of your motor home. Know the weight of your unit and observe any posted weight limits.

Remember: Always use your seat belt and be sure your passengers do so as well. We also advise making frequent rest stops while traveling to relieve stress on yourself, your passengers and your vehicle.

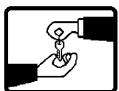

SERVICE AND ASSISTANCE

Your dealer will be glad to provide any additional information you need, as well as answer any questions you might have about operating the equipment in your motor home. When it comes to service, remember that your dealer knows your vehicle best and is interested in your satisfaction.

Your dealer will provide quality maintenance and any other assistance that you may require during your ownership of this vehicle.

If you need warranty repairs while traveling, however, you may take your motor home to any Winnebago or Itasca dealership and they will assist you.



WARRANTY

Your new vehicle is covered by a factory warranty against defects in material and workmanship. This warranty should be validated immediately and returned to the factory by your dealer. For additional information, see your “New Vehicle Limited Warranty” included with this vehicle.



DRINKING AND DRIVING

Winnebago Industries supports the recommendations of the Presidential Commission on Drunk Driving.

- Exercise your good judgment and encourage others to do the same.
- Know the legal limits and do not exceed them.
- Also know your personal limits, which may be lower than the legal limits.
- Should you ever exceed your limits, find alternative transportation; call a cab, ask a friend to drive you home or call a family member to come and get you.

The presence of alcohol in significant levels in the blood increases the probability that the driver will be involved in an accident.

REPORTING SAFETY DEFECTS

If you believe that your vehicle has a defect which could cause a crash or could cause injury or death, you should immediately inform the National Highway Traffic Safety Administration



(NHTSA) in addition to notifying Winnebago Industries, Inc.

If NHTSA receives similar complaints, it may open an investigation, and if it finds that a safety defect exists in a group of vehicles, it may order a recall and remedy campaign. However, NHTSA cannot become involved in individual problems between you, your dealer, or Winnebago Industries.

To contact NHTSA, you may either call the Auto Safety Hotline toll-free at 1-800-424-9393 (or 366-0123 in Washington, D.C. area) or write to: NHTSA, U.S. Department of Transportation, Washington, D.C. 20590. You can also obtain other information about motor vehicle safety from the Hotline.



VEHICLE CERTIFICATION LABEL

This label contains vehicle identification and other important reference information. The vehicle certification label is located on the sidewall to the left of the steering wheel, or on the driver's door. Never remove or destroy this label.

MANUFACTURED BY 		INCOMPLETE VEHICLE MANUFACTURED BY ① MOTOR CORP.	
③ GAWR:		MONTH AND YEAR OF MANUFACTURE: ② GVWR ④ LB _____ KG	
FRT _____ LB _____ KG RR. ⑤ LB _____ KG	SUITABLE TIRE AND RIM CHOICE TIRE _____ ⑥ _____ ⑦	COLD INFLATION PRESSURE PSI _____ KPA SINGLE ⑧ PSI _____ KPA ⑨	
THIS VEHICLE CONFORMS TO ALL APPLICABLE FEDERAL MOTOR VEHICLE SAFETY STANDARDS IN EFFECT ON THE DATE OF MANUFACTURE SHOWN ABOVE.			
SERIAL NO. ⑩ TYPE _____ ⑫		VIN _____ ⑪ MODEL _____ ⑬ COLOR _____ ⑭	

EXPLANATION OF DATA

1. Chassis manufacturer.
2. Chassis manufacture date.
3. Month and year of manufacture at Winnebago Industries.
4. Gross Vehicle Weight Rating: Total permissible weight of the vehicle, including driver, passengers, total cargo carried (including all liquids) and equipped with all options.
5. Gross Axle Weight Rating: Total permissible weight allowed for the front and rear axles (listed in pounds and kilograms).
6. Suitable Tire Choice: Tires recommended to meet handling and safety requirements. When replacing any of the tires on your vehicle, always replace with a tire that meets these specifications.
7. Suitable Rim Choice: Wheel rims recommended to meet handling and safety requirements. When replacing any of the rims on your vehicle, always replace with a rim that meets these specifications.
8. Cold Inflation Pressure: Inflation pressures recommended (while Cold) for the tires originally equipped on your vehicle. These pressure levels must be maintained to assure proper handling, safety and fuel economy.
9. Rear Axle Wheel Configuration: Single or Dual.
10. Serial Number: This is the serial number assigned to the completed vehicle by Winnebago Industries.
11. Vehicle Identification Number (VIN): This number identifies the chassis on which the motor home is built. The 10th digit of the VIN designates the chassis model year. (2=2002, 1=2001). This information is useful when ordering chassis repair parts.
12. Type: States the NHTSA designated usage classification for your motor home. MPV signifies a Multi-purpose Passenger Vehicle.
13. Model: Lists the Winnebago product model number of your vehicle.
14. Color: Signifies the color code number of the decor used throughout the vehicle. This number is necessary for ordering replacement cushions, curtains, carpet, etc.





EXTERIOR FEATURE IDENTIFICATION

Model 39T shown for illustration purposes only.
Actual locations of features depends on coach model and options.

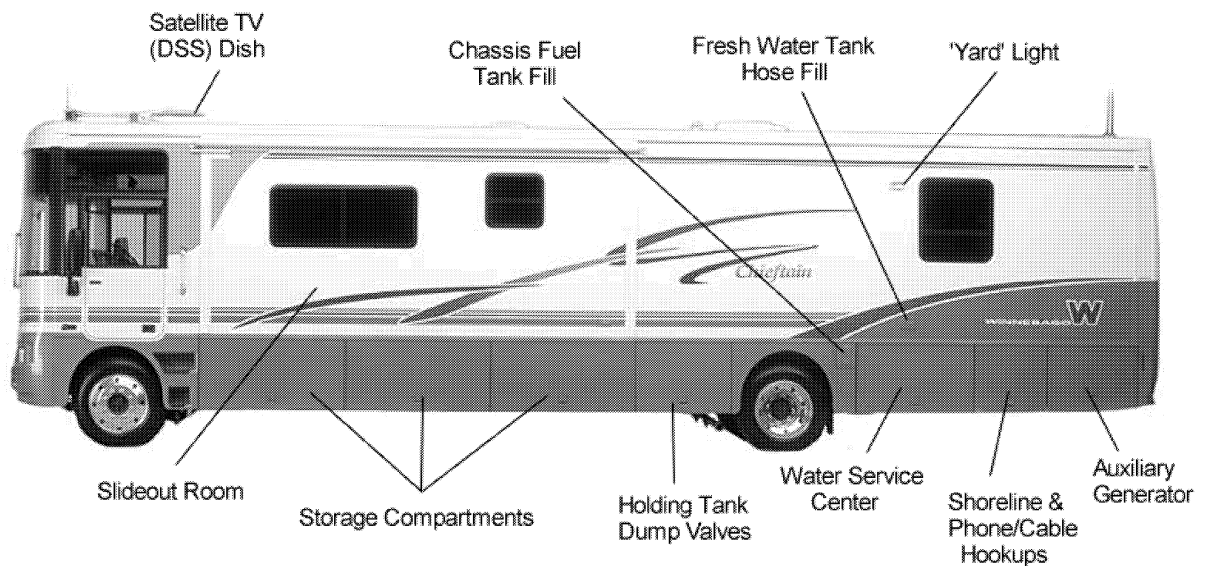
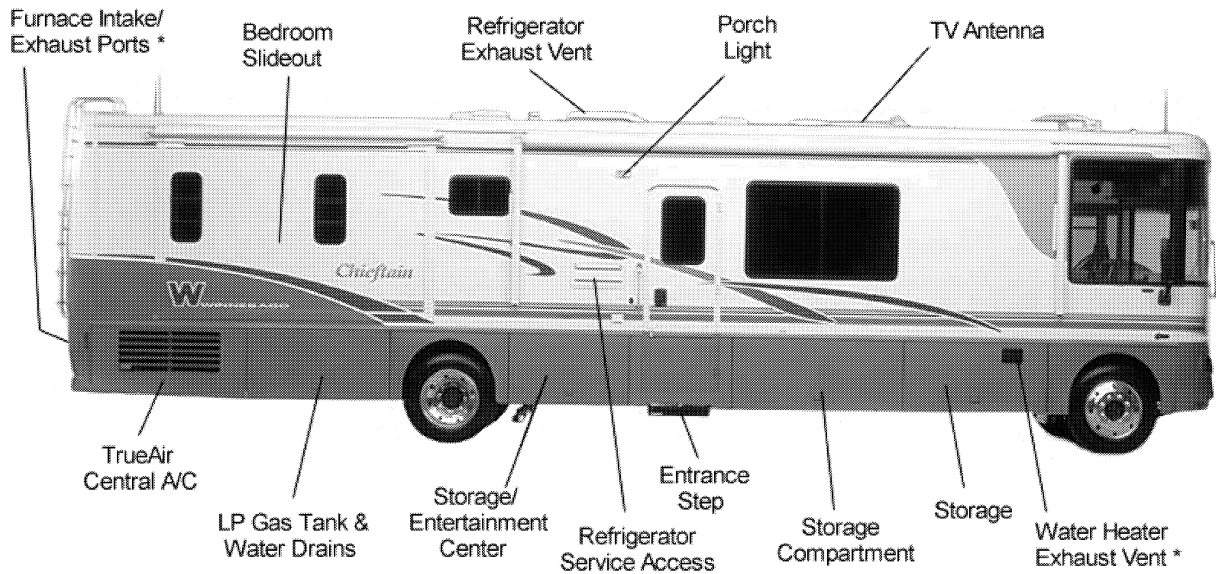

NOTE: Some equipment shown may be optional.

*CAUTION: Be careful. Exhaust outlet surfaces may be HOT while water heater or furnace are in use.



Read and understand all instructions and precautions in this manual before operating your new motor home. Throughout this manual, certain items are labeled NOTE, CAUTION and WARNING. These terms alert you to precautions that can involve risk to your vehicle or to your personal safety. Read and follow them carefully.

NOTE: Indicates special point of information.

CAUTION

Indicates that a failure to observe can cause damage to vehicle or equipment

WARNING

This symbol is used to alert you to precautions that involve your personal safety as well as vehicle damage. Read and follow them carefully.

Listed below are some safety precautions that must be adhered to. These precautions as well as others that involve damage to equipment are also listed in the appropriate areas in this manual.



GENERAL WARNINGS

- Only seats equipped with seat belts are to be occupied while the vehicle is moving.
- Make sure all passengers have seat belts fastened in a low and snug position so the force exerted by the belt in a collision will be spread across the strong hip area. Pregnant women should wear a lap-shoulder belt whenever possible, with the lap belt portion worn low and snug throughout the pregnancy.

- All seats which can be positioned, such as swiveling, sliding, reclining, or footrest out, must be placed in a fully upright and swivel-locked position with footrests retracted while the vehicle is moving. Some swivel lounge chairs are designed to lock in a forward facing position, while others lock in an aisle facing position. Be certain these seats are secure from swiveling before traveling.
- Never let passengers stand or kneel on seats while the vehicle is moving.
- Sleeping facilities are not to be utilized while vehicle is moving.
- Examine the escape window and be familiar with its operation, but do not use except in an emergency.
- Inspect the fire extinguisher monthly for proper charge and operating condition. This should also be done before beginning a vacation or any extended trip.



DRIVING

- Do not attempt to adjust the driver's seat while the vehicle is moving.
- Do not adjust tilt steering in a moving vehicle.
- Do not operate the cruise control on icy or extremely wet roads, winding roads, in heavy traffic, or in any other traffic situation where a constant speed cannot be maintained.
- Use care when accelerating or decelerating on a slippery surface. Abrupt speed changes can cause skidding and loss of control.
- Driving through water deep enough to wet the brakes may affect stopping distance or cause the vehicle to pull to one side. Check



SECTION 1
SAFETY PRECAUTIONS

Chieftain

brake operation in a safe area to be sure they have not been affected. Never operate any vehicle if a difference in braking efficiency is noticeable.

- Adverse weather conditions and extremes in terrain may affect handling and/or performance of your vehicle. Refer to your chassis manual for related information.



FUEL & LP GAS



- All pilot lights must be extinguished and appliances turned off while refilling the fuel tank or LP tank.
- Never smoke while refilling vehicle fuel tank or LP gas tank.
- Avoid inhaling exhaust gases produced by burned gasoline, diesel fuel or LP gas in items such as the range, chassis engine, generator engine, refrigerator, furnace and water heater. They contain carbon monoxide, which is an odorless, colorless and poisonous gas.
- Do not bring or store LP gas containers, gasoline or other flammable liquids inside the vehicle because a fire or explosion may result. LP gas containers are equipped with safety valves which relieve excessive pressure by discharging gas to the atmosphere.
- Do not fill LP gas container(s) above 80 percent of capacity. Overfilling the LP gas container can result in uncontrolled gas flow which can cause fire or explosion. A properly filled container will contain approximately 80 percent of its volume as liquid LP gas.
- Never use an open flame to test for LP gas leaks. Replace all protective covers and caps on LP system after filling. Make sure valve is closed and door latched securely.

- Never connect natural gas to the LP gas system.
- When lighting range burners do not turn burner controls to “On” and allow gas to escape before lighting match.
- Portable fuel-burning equipment, including wood and charcoal grills and stoves, shall not be used inside the recreational vehicle. The use of this equipment inside the recreational vehicle may cause fires or asphyxiation.
- LP gas regulators must always be installed with the diaphragm vent facing downward. Regulators are equipped with a protective cover. Make sure that the regulator vent faces downward and that the cover is kept in place to minimize vent blockage which could result in excessive gas pressure causing fire or explosion.
- The following warning label is located in the cooking area to remind you to provide an adequate supply of fresh air for combustion.



Unlike large homes, the oxygen supply inside a recreational vehicle is limited due to its size. To avoid danger of asphyxiation, provide proper ventilation when using the gas rangetop or gas oven. It is especially important that the gas oven and range top not be used for comfort heating. Danger of asphyxiation is greater when these appliances are used for long periods of time.



LP GAS LEAKS

The following label is located in the vehicle near the range area. If you smell gas within the vehi-



cle, quickly and carefully perform the procedures listed.

IF YOU SMELL GAS

1. Extinguish any open flames, pilot lights and all smoking materials.
2. Do not touch electrical switches.
3. Shut off the gas supply at the tank valve(s) or gas supply connection.
4. Open doors and other ventilating openings.
5. Leave the area until odor clears.
6. Have the gas system checked and leakage source corrected before using again.



LP GAS ALARM

Your coach is equipped with an LP gas detector which sounds an alarm if an unsafe amount of LP gas is present inside the coach. Because LP gas is heavier than air, the detector is located on a cabinet face near the floor of the coach.

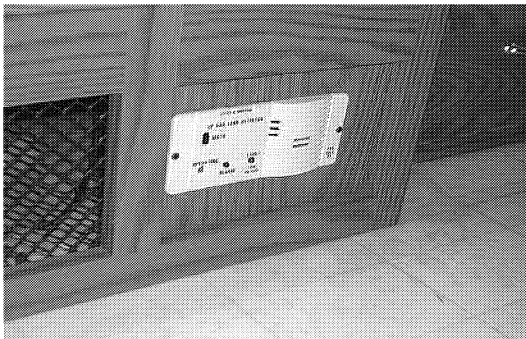

A green light on the face of the alarm shows when the unit is active. If the detector senses LP gas, the alarm will make a loud, pulsating sound and the red light will come on. Pressing the "MUTE" button will stop the alarm for 60 seconds. If there is no more detectable LP gas, the alarm will stay off. If the detector still senses LP gas by the end of the 60 second mute mode, the alarm will sound again.

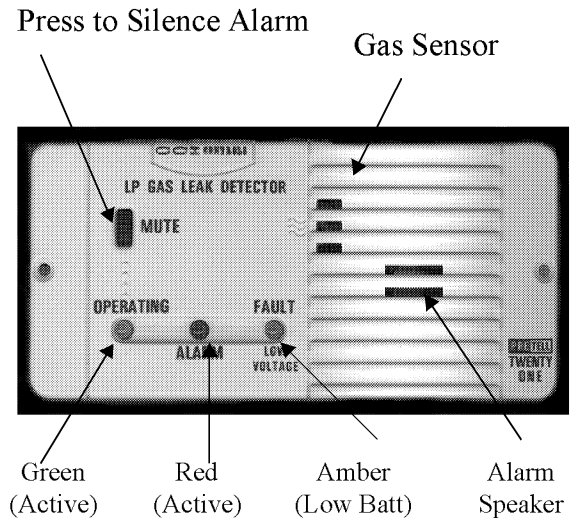

If The Alarm Sounds

If the alarm sounds, do not touch any electrical switches. Immediately turn off the main LP tank valve and all LP appliances, open all windows and roof vents, and leave the coach until the alarm stops sounding.

If the alarm keeps sounding at regular intervals, a leak may be present. Contact your dealer or an LP gas service center to have the problem corrected before using the LP system again.

WARNING

Never use an open flame to test for gas leaks. When testing for gas line leaks with a soapy water solution, DO NOT use a detergent containing ammonia or chlorine. These substances may generate a chemical reaction causing corrosion to gas lines, resulting in dangerous leak conditions.

Power Connection

The gas alarm is powered by the coach batteries. If the battery cable is disconnected from the batteries, auxiliary battery switch is shut off, or the circuit breaker is tripped, the alarm will not work. The LP gas alarm breaker is located on the coach circuit breaker panel shown on page 6-7.

Because the LP gas alarm is connected directly to the auxiliary battery, it is always drawing a



SECTION 1 SAFETY PRECAUTIONS

Chieftain

small amount of current. Even though this current draw is slight, it could drain the coach battery during storage periods of 30 days or longer. We recommend turning the auxiliary battery switch off or disconnecting the battery cables from the auxiliary battery during extended storage periods to avoid discharge.

If the coach batteries become extremely drained (8.5 volts or less), the amber Low Voltage/FAULT light on the face of the alarm will come on, and in some rare cases the LP alarm may begin to sound on its own. This condition is not likely to occur except during storage situations when coach battery charge is not being restored by the converter charger or solar charger.

Other Combustible Fumes or Vapors

This alarm is designed to detect the presence of LP gas, however there are other combustible fumes or vapors which may be detected by the sensor. These include: alcohol, liquor, deodorants, colognes, perfumes, wine, adhesives, lacquer, kerosene, gasoline, glues, most all cleaning agents and the area is closed up. Glues and adhesives may exhaust hydrocarbon vapors for months after they are applied. They are easily activated by high temperatures. If you close up an RV coach on a hot day, the chemicals used in its construction may be detected for months after the coach was manufactured.

Further Information

See the manufacturer's information entitled "Your LP Gas Detector" in the InfoCase for further instructions on nuisance alarms and care and testing of the LP gas detector.



ELECTRICAL

- Careless handling of electrical components can be fatal. Never touch or use electrical components or appliances while feet are bare, while hands are wet, or while standing in water or on wet ground.
- Improper grounding of the vehicle can cause personal injury. Do not plug the utility power cord into an outlet which is not grounded and

do not adapt the plug to connect to a receptacle for which it is not designed.

- Do not attach an extension cord to the utility power cord.
- Be sure that all electrical appliances to be used contain 3-prong plugs for proper grounding.
- Avoid overloading electrical circuits. Replace fuses or circuit breakers with those of the same size and amperage rating only. Never use a higher rated fuse or breaker.
- Use caution when handling or working near electrical storage batteries. Always remove jewelry and wear protective clothing and eye covering. Avoid creating sparks.

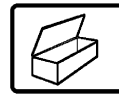

LOADING

- Store or secure all loose items inside the motor home before traveling. Possible overlooked items such as canned goods or small appliances on the countertop, cooking pans on the range, or free-standing furniture items can become dangerous projectiles during a sudden stop.
- Be aware of GVWR, GAWR and individual load limit on each tire or set of duals. (See "Loading the Motor Home" in Section 4.)
- Never load the motor home in excess of the gross vehicle weight rating or the gross axle weight rating for either axle.

NOTE: Your motor home's load capacity is designated by weight, not by volume, so you cannot necessarily use all available space when loading your motor home. See page 4-1 for more information.



MAINTENANCE

- Do not remove the radiator cap while engine and radiator are still hot. Always check coolant level visually at the see-through coolant reservoir.
- Never get beneath a vehicle that is held up by a jack.
- Do not mix different construction types of tires on the vehicle such as radial, bias or belted tires, as vehicle handling may be affected. Replace tires with exact size, type and load range.
- Do not attempt to start the vehicle by hot wiring.

FORMALDEHYDE INFORMATION

WARNING

Some components in this vehicle contain formaldehyde based adhesives which may release formaldehyde fumes into the air for an unknown period of time until total dissipation occurs. Individuals who are allergic to formaldehyde gas fumes may experience irritation to eyes, ears, nose and throat. Reaction in infants may be more severe. Although long range effects are not well understood, testing to date has not revealed any serious health effects in humans at the level of emission from these products.

IMPORTANT

To aid in dissipation, ventilate the vehicle by opening all windows and circulating the air with a fan.



CARBON MONOXIDE WARNING

WARNING

Avoid inhaling exhaust gases, as they contain carbon monoxide, which is a colorless, odorless and poisonous gas.

If you suspect that exhaust fumes are entering the passenger compartment, have the cause determined and corrected as soon as possible. If you must drive under these conditions, drive only with **ALL WINDOWS FULLY OPENED**.

The best protection against carbon monoxide entry into the vehicle body is a properly maintained engine exhaust and ventilation system. It is recommended that the exhaust system and body be inspected by a qualified motor home service center.

- Each time the vehicle is raised for an oil change.
- Whenever a change in the sound of the exhaust system is noticed.
- Whenever the exhaust system, underbody or rear of the vehicle is damaged.

To allow proper operation of the vehicle's ventilation system, keep front ventilation inlet grill clear of snow, leaves or other obstructions at all times. **DO NOT OCCUPY A PARKED VEHICLE WITH ENGINE RUNNING FOR AN EXTENDED PERIOD.**

Do not run engine in confined areas, such as a garage, except to move vehicle in or out of area. When vehicle is stopped in an **UNCONFINED** area with the engine running for any more than a short period, adjust heating or cooling system to force outside air into the vehicle as follows:

1. Set fan to medium or high speed and vent control to air.
2. On vehicles equipped with air conditioning, set fan to medium or high speed and set control to obtain maximum vent air.

Rear bedroom windows should be closed while driving to avoid drawing dangerous exhaust gases into the vehicle.



SECTION 1 SAFETY PRECAUTIONS

Chieftain

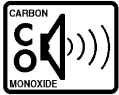

CARBON MONOXIDE ALARM

If your coach is equipped with a carbon monoxide (CO) alarm, it will be located on the ceiling in the bedroom area.

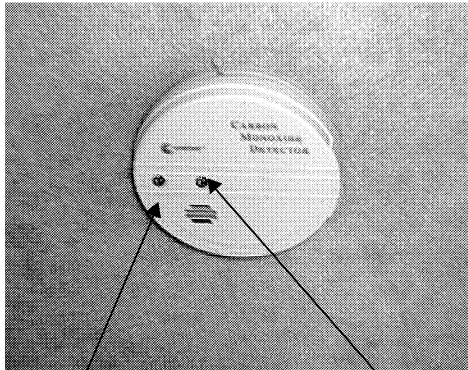

Red Light
(Press to test alarm)

Yellow Light
(Warning)

The CO alarm is powered by a 9-volt battery and contains a sensor that is designed to detect toxic carbon monoxide gas fumes resulting from incomplete combustion of fuel. It will detect CO gas from any combustion source such as the furnace, gas range/oven, water heater, refrigerator, chassis engine, and electric generator engine.

Monthly Testing

Press the TEST button on the face of the alarm periodically (at least monthly) to check the function of the alarm and condition of the battery. If the alarm begins to beep every few seconds, the battery may be weak and need replacement. (Press the TEST button to be sure before replacing the battery. If the alarm sounds, the battery may still be okay. If the alarm still beeps every few seconds, check the smoke detector also. The "low battery" warning beep is similar on many alarm devices, so the origin of this electronic sound can be deceiving.)

Further Information

Please read the information provided by the manufacturer, which is included in your Info-Case. It includes information on precautions, operational testing, and battery/sensor replacement.



EMERGENCY EXITS Emergency Exit Windows

Your motor home is equipped with an emergency exit window in the bedroom of the coach that functions as an escape exit in an emergency situation.

Side Escape Window

The side mounted escape window is secured by two red safety latches and can be opened by first releasing these two latches and then pushing outward on the lower part of the window. Identify which type of emergency exit window is in your vehicle.

Instructions for removal are also located near the latches for quick reference and for passengers who may not be familiar with the exit. Never remove or destroy this label.

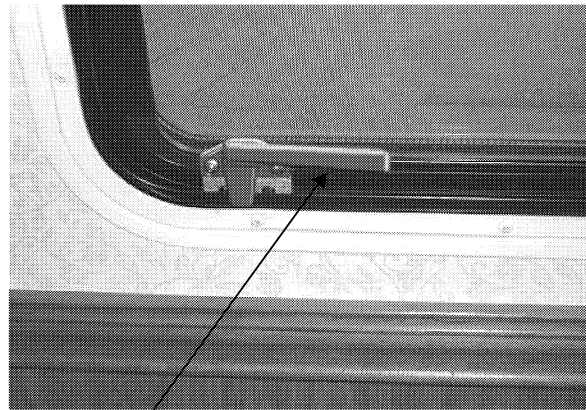

Lift Both Handles Up
Push Out on Bottom

Using Slider Windows as Emergency Exits

Most slider windows along the side of the motor home can also be used as emergency exits, should the need arise. To use the windows as exits, slide the window glass and screen open.



FIRE EXTINGUISHER

A dry chemical fire extinguisher is located near the entrance door.



We recommend that you become thoroughly familiar with the operating instructions displayed on the side of the fire extinguisher or in the information supplied in your InfoCase.

We also recommend that you inspect the fire extinguisher for proper charge at least once a month in accordance with National Fire Protection Association (NFPA) recommendations as stated on the label.

If the charge is insufficient, the fire extinguisher must be replaced.

WARNING

Do not test the fire extinguisher by discharging it. Partial discharge can cause leakage of pressure or contents which would render the unit inoperative when needed. When using the fire extinguisher, aim the spray at the base of the fire.



SMOKE ALARM

Your motor home is equipped with a smoke alarm located on the ceiling in the galley area. This alarm meets U.L. Standard 217 and NFPA Standard 74 for operation of smoke detection devices.

1. The smoke alarm should be tested for correct operation each time the vehicle is brought out of storage, before each trip, and at least

once a week during motor home use. To test the electronics, firmly depress the button. To test that smoke reaches the sensor, blow smoke in a careful, fire-safe manner into your smoke alarm.

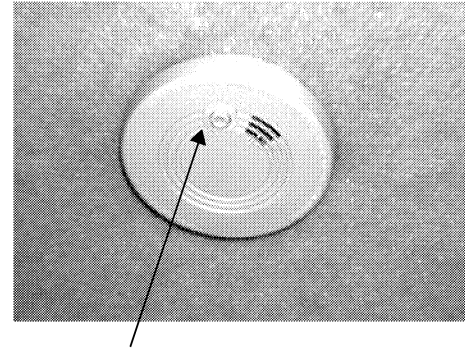

Press to
test

2. Your smoke alarm will not work without power. Never remove the battery to quiet the alarm. When your smoke alarm “beeps” about once a minute the battery is weak. Install a new battery immediately. Be sure to use only batteries specified in manual or on unit. Test unit after installing a new battery.
3. Clean and vacuum the openings on your smoke alarm once a month.
4. Do not open the smoke alarm or try to repair it. For replacement information see warranty in Owner’s Manual.
5. Smoke alarms have technical limitations and may not respond in all situations. FIRE PREVENTION is your best safeguard.

See your InfoCase for further information.



(See also Safety Precautions, Section 1 of this manual.)

NOTE: See your Workhorse chassis operator's guide for information on starting the engine, operating the transmission, steering column controls descriptions of instrument gauges and other chassis related information.

Some items described in this section may be optional or unavailable on your coach.

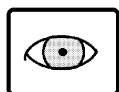

BEFORE ENTERING YOUR VEHICLE

Before entering your vehicle, there are a few recommended procedures that will aid in your driving safety and equipment.

1. Be sure that the windows, mirrors and light lenses are clean and unobstructed.
2. Make sure all exterior lights operate properly.
3. Check tires for proper cold inflation pressures.
4. Check wheel lug nuts for tightness.
5. Look beneath the vehicle for noticeable fluid leakage.
6. Check fluid levels and fill if necessary. This includes engine oil, transmission fluid, coolant, brake fluid, power steering fluid and windshield washer solvent.

WARNING

The engine should be shut off unless specifically required for a certain procedure.

Transmission must be in P (Park) and park brake applied while performing any checks or adjustments.

7. Unhook and store sewer and water supply hoses.
8. Retract step.
9. Be sure that all of your cargo is secured in event of a sudden stop or an accident.
10. Check around your vehicle in all directions to assure that you have proper clearance.
11. Lower TV antenna.
12. Disconnect and store shoreline.

WARNING

Before driving your vehicle, be sure you have read the entire operator's manual and that you understand your vehicle's equipment completely and how to use the equipment safely.



BEFORE DRIVING YOUR VEHICLE

Before preparing to drive your vehicle, here are a few recommended procedures that will add to your driving safety and enjoyment.

1. Be sure that you adjust the interior and exterior rear view mirrors to your driving preference.
2. Adjust the driver's seat for proper distance from foot pedals and steering wheel to allow for safety and ease in controlling your vehicle.
3. Place front seats in the forward facing position.



4. Be sure to fasten all safety belts to fit you comfortably, but tight enough to obtain the full safety of the belts.
5. Make sure all doors are completely shut and locked. When the doors are shut and locked, there is less chance of the doors flying open in event of an accident. It also prevents unintentional opening of doors and keeps intruders out of your vehicle.
6. Check to see that all gauges are operating properly.
7. Check the fuel level in the vehicle.
8. Be certain that the fire extinguisher is fully charged and secure in its mounting bracket.

CAUTION

Be sure hood and all compartment doors are latched securely before driving vehicle

GASOLINE FUEL FILL

Removing the Fuel Cap

When removing the gasoline cap, slowly rotate it **only far enough to allow pressure to release**. After any "hissing" sounds stop, continue removing the cap.

Filling the Tank

Do not overfill the fuel tank. Allow gasoline to pump into the tank until the auto-shutoff valve in the fuel pump nozzle stops the flow of fuel, indicating a full tank. This provides a pre-determined vapor space at the top of the tank to allow for expansion of the gasoline.

CAUTION

Continuing to fill above this level may cause damage to the fuel/evaporative emission system.

Replacement Fuel Caps

To protect gasoline system from excessive pressure or vacuum, or from sudden pressure, replace lost caps with caps of the same design available from your Winnebago Industries dealer.



FUEL INFORMATION

Fuel Tank Capacity:

Workhorse chassis 75 gal. (nominal)

FUEL SELECTION

Refer to your chassis operating guide for the manufacturer's recommendations on proper fuel selection.

WARNING

Modern fuel systems may build up pressure within the tank as the gasoline warms during use or in hot weather.

Under certain conditions, sudden release of this pressure when removing the gasoline cap can spray gasoline from the fuel fill opening, causing a possible hazard.



STARTING AND STOPPING ENGINE

Refer to your chassis operating guide for the manufacturer's recommendations on starting and stopping the engine.

Brake-Shift Interlock

Ford chassis are equipped with a brake-shift interlock safety feature. The shift lever cannot be moved from the Park position unless the ignition is ON and the service brake pedal is pressed.



PARKING BRAKES

The parking brake pedal is located to the left of the foot service brake.



To set the parking brake, press the service brake pedal firmly with your right foot while you apply the parking brake with your left foot. The BRAKE warning light will go on as soon as you start to press the parking brake pedal. The brake will not prevent the vehicle from moving unless you push it down firmly and fully. Remove your foot from the service brake pedal and make sure there is no vehicle movement.

To release the parking brake, apply the service brake with your right foot and hold the parking brake pedal down with your left foot while you pull the release lever. The release lever is located above the brake pedal.

Never drive your vehicle with the parking brake set as this will reduce parking brake effectiveness and cause excessive wear.

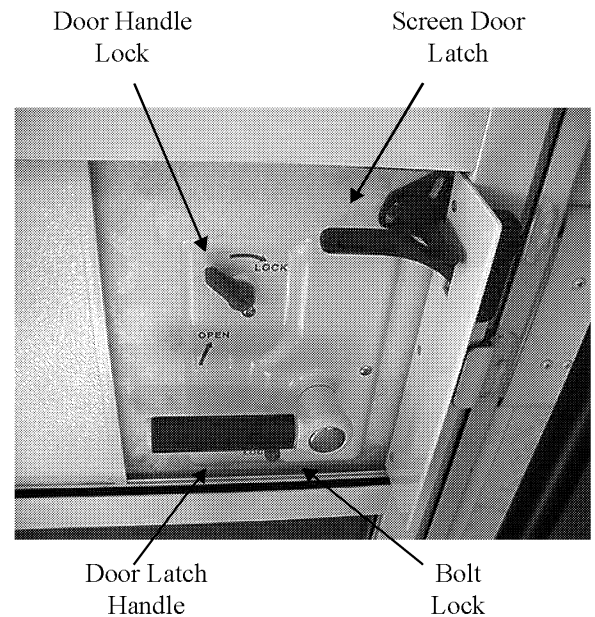

ENTRANCE DOOR LOCK AND HANDLE

The entrance door may be opened by pulling the door handle outward. When the door is locked, neither the inside nor the outside door handle can be operated. It can be locked and unlocked from the outside of the vehicle by inserting the key into the lock and turning.

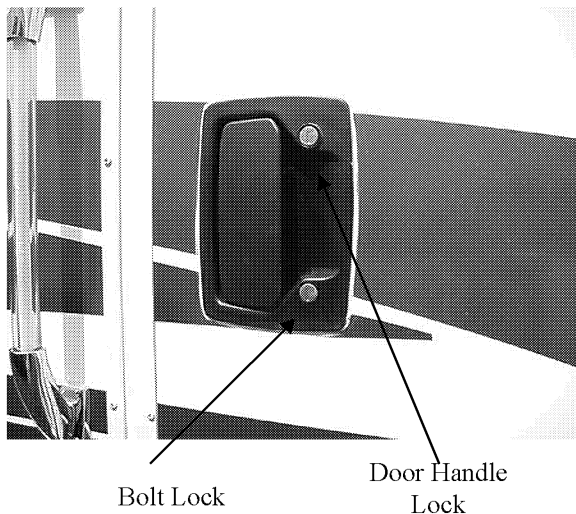

To lock the door from inside, rotate the lock levers as indicated. The deadbolt lock is for added security and should be used as a security night lock.

Lubricate the locks periodically with graphite to maintain good working condition.

CAUTION
When releasing security night lock, be sure to retract bolt before opening door latch to prevent drag on bolt pin. Instruct all passengers in operation of this door catch system as well as emergency exit window.



“KEY ONE” LOCK SYSTEM

Your coach is equipped with the new Key One™ lock system. A single key will open every door lock in the entire motor home (except the security deadbolt lock on the entrance door). This means you don't have to sort through a handful of keys to find the right one for the water fill door or the luggage doors or the entrance door or the driver's door.

The number of the key for your coach is registered in our factory database, so if you ever lose your keys, any Winnebago Industries dealership can easily order a new key for you. They are also



equipped with special master keys and can unlock your coach for you if needed.

NOTE: Keys should always be removed when leaving the vehicle. Since doors can be locked without keys, make sure they have been removed from the ignition before locking the driver's compartment.

The control switches for the power door locks and driver side window are located on the driver door armrest.



Power Door Lock Switch

Power Driver Window Switch

An additional door lock switch is located to the left of the entry door steps as you enter the coach.



Power Lock Switch (near entry steps)



ELECTRIC ENTRANCE STEP

The power switch for the electric entrance step is located to the left of the main entry door as you enter the coach.

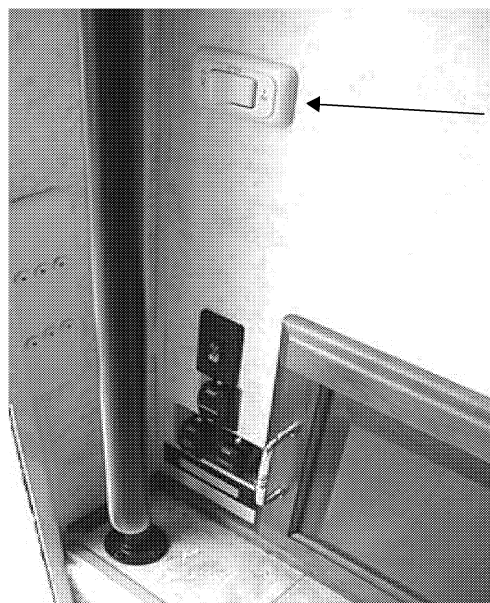

Step Switch

Automatic Mode (Operates with Door)

With the Power Switch in the On position the step is in Automatic Mode. This means it will extend and retract automatically whenever the door is opened or closed. This is done by means of a magnetic door switch attached to the lower hinged edge of the screen door section of the entrance doors. The steps will extend when the screen door is opened, and retract when the screen door is closed. With the power switch in the Off position the step can be kept in the extended or retracted position as described below.

Stationary Extended Mode

To keep the step in the extended position:

- turn the Power Switch to **On**,
- **open** the screen door to extend the step,
- then turn the Power Switch to **Off**.

The step will now stay extended whether the door is opened or closed. This position is normal-



ly used when parked at a campsite or whenever people are going to be entering and exiting the vehicle frequently.

Stationary Retracted Mode

To keep the step in the retracted position:

- turn the Power Switch to **On**,
- **close** the screen door to extend the step,
- then turn the Power Switch to **Off**.

The step will now stay retracted when the screen door is open or closed. This position is normally used where an exterior step is not required or to avoid damage to the step, such as when parked near a high curb or similar object.

Automatic Retraction Feature

The coach is equipped with a step retraction feature that retracts the step automatically when the Ignition Switch key is turned to either the On or Start position regardless of whether the Step Power Switch is On or Off. This feature is standard and is installed to prevent injury or damage which may be caused by an extended step when the vehicle is moving. An associated feature is the “Last Out Feature”. This feature extends the step when the screen door is opened after the ignition switch has been turned to either the On or Start position.

WARNING

Do not use steps unless it is fully extended.

Do Not Stand on step when vehicles ignition switch is turned to either the “On” or “Start” position. The step will automatically retract, which may cause personal injury. Always remember to retract the step before moving the vehicle.

For additional information on the step, see the step manufacturer’s operators manual included in your Owners *InfoCase*.

CAUTION

Always remember to retract the entrance steps before traveling or moving the vehicle.



LUGGAGE COMPARTMENT DOORS

To ensure that compartment doors have latched properly, press the bottom edge of the door with the palms of your hands.

This is more important for smaller and lighter compartment doors because when the door is “dropped” closed, the air trapped inside the compartment may create a cushioning effect that could prevent door latches from engaging properly.

The power switch for the compartment lights is located to the left of the main entry door as you enter the coach.



Compartment Lights Switch



SEATS

The driver and co-pilot seats may be independently adjusted to suit individual preference. To move the seat forward or backward, press the slide release button, located on the side of the seat, and exert slight body pressure in the direction desired.



The seats may be swiveled to provide easy entrance and exit. The swivel feature also allows the seats on some models to be turned toward the living area for additional seating while the unit is parked.

To swivel the seats: Press the release button, located on the side of the seat, and rotate seat. The seats are designed to lock only when returned to the forward facing position.

NOTE: If your seats are equipped with power seat controls, the swivel release button is located beneath the seat on the right side of the seat.

To recline the seats: Lift the reclining lever, lean back to desired incline and release the lever. To return to the upright position, lift the lever and lean body forward. Allow the seat to return to the desired position and release the lever.

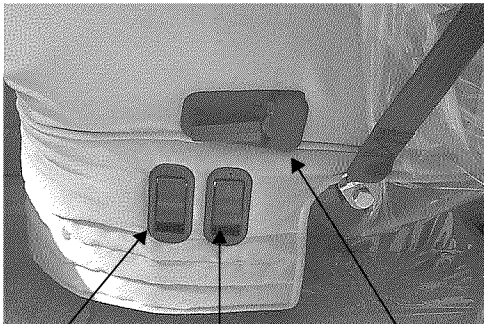

Slide Release Swivel Release Recline Lever

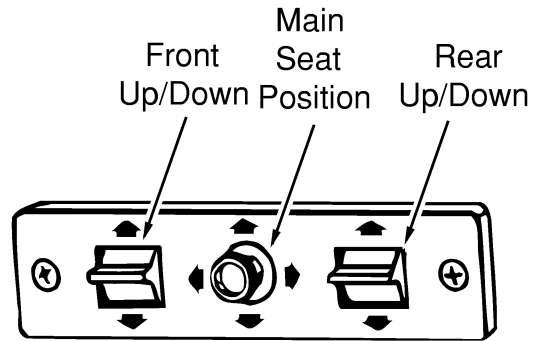

Power Seat Control

ARM REST ADJUSTMENT

The driver and co-pilot seat armrests may be adjusted to various positions for comfort while sitting upright or reclined. Turn the knob on the end of the armrest clockwise (tighten) to raise the angle or counterclockwise (loosen) to lower the angle.

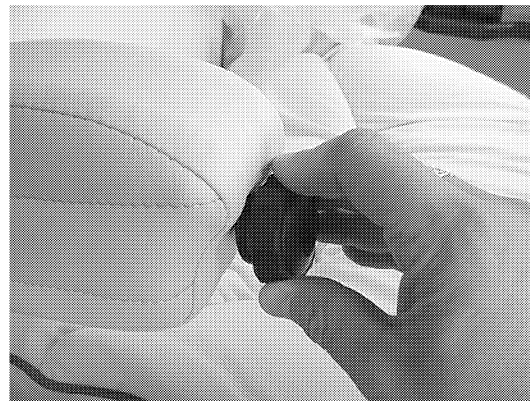

Armrest Adjustment Knob
*Tighten to Raise
*Loosen to Lower

WARNING
Do not adjust driver's seat while vehicle is in motion.

After adjusting seat, always use body pressure to make sure slide and swivel locking mechanism have engaged.

6-Way Power Seat Controls

The power seat controls are located on the lower right hand side of the seat base.

DRIVER SEAT LUMBAR SUPPORT

The driver seat lumbar area can be adjusted to provide lower back support while driving. The adjustment lever is at the left side of the driver seat. Rotate the lever down and to the rear to increase firmness.



Lumbar Support Lever
Firm Position

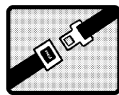

SEAT BELTS

Seats intended for occupancy while the vehicle is in motion are equipped with seat belts for the protection of the driver and passengers.

Lap Belts

The lap belts must be worn as low as possible and fit snugly across the hip area. Always sit erect and well back into the seat. To gain full protection of the safety belt, never let more than one person use the same safety belt at any one time, and do not let the safety belts become damaged by pinching them in the doors or in the seat mechanism. After any serious accident, any seat belts which were in use at the time should be replaced.

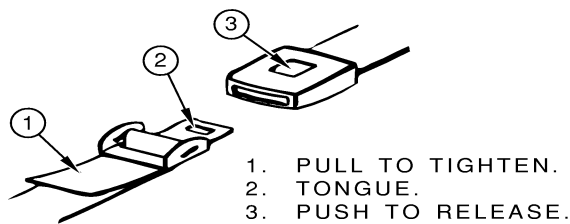

Adjustment: To lengthen belt, turn tongue at a right angle to belt and pull to desired length. To shorten, pull loose end of belt.

To Fasten: Be sure belt is not twisted. Grasp each part of the belt assembly and push tongue into buckle. Adjust to a snug fit by pulling the loose end away from the tongue.

To Release: Press button in center of buckle and slide tongue out of buckle.

WARNING

Snug and low belt positions are essential. This will ensure that the force exerted by the lap belt in a collision is spread over the strong hip area and not across the abdomen, which could result in serious injury.

Only seats equipped with seat belts are to be occupied while vehicle is in motion.



THREE-POINT LAP-SHOULDER BELTS

The driver and co-pilot seat belts in your coach are equipped with automatic locking retractors that let you easily adjust your seat belt to the proper length for passenger safety.

Fastening:

- Grasp the belt just behind the tongue using the hand nearest the door or sidewall. Be sure the belt is not twisted before fastening.
- Pull the belt smoothly outward from the wall and across your body, then insert the tongue into the buckle on the aisle side of the seat until it locks with a positive “click”.
- The lap belt portion must be worn snug and low across the pelvic area.
- The shoulder strap portion must be worn diagonally across the chest and over the shoulder, but not against the neck.

NOTE: The shoulder belt height can be adjusted to provide the most comfortable position for each individual person's size. To adjust shoulder belt height, press the lever down, select the desired position and release the lever. (See following photo.) A



ratcheting mechanism will allow the belt to be pushed upward but not pulled downward.



- Seat belts offer optimum protection only when worn properly on the body and when the seat is in an upright position.

WARNING

Never wear the shoulder belt in any position other than as stated above. Failure to do so could increase the chance or extent of injury in a collision

Unfastening:

- Press the release button in the buckle.
- Hold onto the tongue when you release it from the buckle to keep it from retracting too rapidly.

Care and Cleaning

- Be careful not to damage the belt webbing and hardware. Take care not to pinch them in the seat or doors.
- Inspect the belts and hardware periodically. Check for cuts, frays, and loose parts. Damaged parts should be replaced. Do not remove or modify the belt system.

- Keep belts clean and dry. If the belts need cleaning, use only a mild soap and water solution. Do not use hot water. Do not use abrasive cleaners or bleach. These products may weaken or damage the belts.
- Replace any belt assembly that was used during a severe impact. Replace the complete assembly even if damage is not apparent.



CHILD RESTRAINTS

All 50 of the United States and the District of Columbia now require the use of the child/infant restraint systems for children in vehicles.

A properly installed and secured child restraint system can help reduce the chance or severity of personal injury to a child in an accident or during a sudden maneuver. Children may be injured in an accident if they are not seated in a child restraint which is not properly secured.

A child restraint system is designed to be secured in a vehicle seat by a lap belt or the lap belt portion of a lap-shoulder belt. According to accident statistics, children are also safer when properly restrained in rear seating positions than in front seating positions.

When purchasing a child restraint system:

1. Look for the label certifying that it meets all applicable U.S. Federal Motor Vehicle Safety Standards (FMVSS) or, in Canada, requirements of the Children's Car Seats and Harnesses Regulations (CCSHR).
2. Make sure that it will attach to your vehicle and restrain your child securely and conveniently so that you are able to install it correctly each time it is used.
3. Be certain that it is appropriate for the child's height, weight and development. The instructions and/or the regulation label attached to the restraint typically provides this information.
4. Review the instructions for installation and use of the restraint. Be sure that you understand them fully and can install the restraint properly and safely in your vehicle.



POWER ELECTRIC MIRRORS

Always adjust mirrors for maximum rear visibility before driving off. Make sure the seat is adjusted for proper vehicle control and that you are sitting back squarely into the seat.

The electric mirrors are adjusted using a multi-directional switch located on the driver's door panel to the left of the steering wheel.



Mirror Adjustment Control

Mirror Heat Switch

Select the mirror to be adjusted by pushing the switch in the middle of the control to the right or left. Then press the arrow buttons as necessary to obtain the best view.

When mirrors are adjusted to preference, place the selector switch back in the middle position to cancel power to the buttons. This prevents accidental misadjustment of mirror settings.

The mirrors also contain heating elements to defog or de-ice the mirror glass during cold weather operation. An ON-OFF switch for the mirror heaters is located near the remote mirror controls.

Press to move mirror in indicated direction

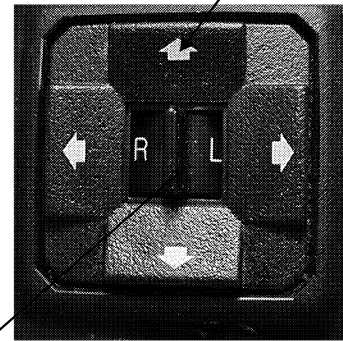

Move L or R to select mirror, or center for "neutral".

The power mirror control switch is intended for fine adjustment of the mirrors. If you cannot adjust the mirror properly using the control switch, the mirror may need a coarse adjustment by repositioning the mirror head. See the mirror manufacturer's instructions in your Owner InfoCase.

More Info

To read more about power mirrors, see the mirror manufacturer's information in your Owner InfoCase.



SONY REARVIEW TV MONITOR SYSTEM



Refer to the InfoCase for specific instructions provided by Sony.



ELECTRONIC COMPASS & OUTSIDE THERMOMETER



COMPASS OPERATION

The compass has two (2) buttons - MODE and °F/°C - which are used to change the unit between the various operating modes.

Ignition On Operation:

1. Unit displays outside temperature and compass heading.
2. Press the °F/°C button to toggle between displaying °C and °F.
3. If the unit has been properly calibrated, the heading will remain 'on' continuously. If the unit does not have a valid calibration, the heading and the word 'CAL' will flash continuously.
4. If the temperature reading is valid, the temperature display will remain 'on' continuously. If the temperature reading is invalid (due to an open or shorted temperature sensor), the temperature reading will flash continuously.
5. Unit goes to SLEEP MODE when ignition is turned off.

Sleep Mode Operation:

1. Unit enters SLEEP MODE when ignition is turned off.
2. The display is blank and the unit is in a LOW POWER MODE.
3. Unit wakes from SLEEP MODE and enters:
 - A. Ignition ON operation when the ignition is turned on, or
 - B. CAMPING MODE when the °F/°C or the MODE button is pressed for three (3) seconds.

Camping Mode Operation:

1. Unit enters CAMPING MODE after the °F/°C button or MODE is pressed for (three) 3 seconds while in SLEEP MODE.

2. Unit displays temperature and heading for ten (10) seconds; the display stays 'on' if you continue to push either button and then returns to SLEEP MODE ten (10) seconds after the last button was pushed.

Nighttime Dimming:

The display brightness is decreased by 50% when the vehicle head lamps are turned on.

Calibration:

The compass must be calibrated after its initial installation and anytime the compass sensor is replaced or relocated. The calibration values are saved in EPROM memory, so it is not necessary to recalibrate if the battery is disconnected.

Calibration Procedure:

1. Press and hold the MODE button until the words 'ZONE' and 'CAL' appear (approximately ten (10) seconds). The unit will display the current zone value.
2. Press the °F/°C button to increment the zone value.
3. Press the MODE button to store the zone value.
4. The unit now displays the word 'CAL'. Press the °F/°C button to enter the calibration mode. The display will begin counting down from 60 seconds and the word 'CAL' will flash. The driver should slowly drive in a circle during the 60 second calibration period. If the calibration procedure failed, the unit will flash the word 'CAL' continuously. If the calibration procedure is successful, the unit will display the word 'CAL' for five (5) seconds and then return to normal ignition 'on' operation.

ZONE ADJUSTMENT

When you travel outside the zone, the unit is currently set 'on', the compass has reduced accuracy. To achieve maximum accuracy, it is recommended to change the zone setting when traveling to a new zone in the U.S. To change the zone setting, follow steps (1.) through (3.) of the CALIBRATION ROUTINE, at which point the unit will display the word 'CAL'. Press the MODE button again to skip calibrating. It is not



necessary to recalibrate the compass when you change zones.

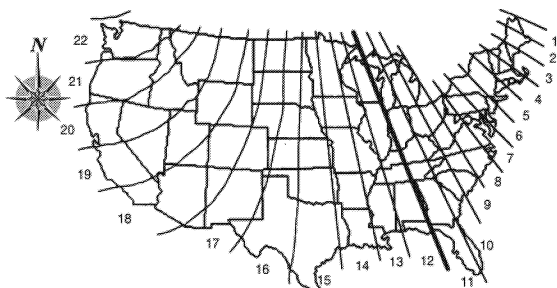

Compass zones for the U.S.

SPECIFICATIONS

Parameter	Min	Avg Typ	Max	Units
Operating Voltage	9	12	18	Volts
Operating Temperature	-40	-	85	°C
Storage Temperature	-55	-	105	°C
Supply Current @12V				
Active Mode		0.3		Amps
Sleep Mode		0.001		Amps
Compass Accuracy	+/-5			Degrees
Compass Resolution			45	Degrees
Temp. Measurement Accuracy	+/-1			°C
Temperature Display	-40		127	°F
	-40		53	°C



INSTRUMENT PANEL GAUGES AND CONTROLS

The illustrations on the following page showing switches and features provided by Winnebago Industries.

See your chassis owner's manual for detailed information on the instrument gauges, steering column controls, brakes, and other chassis original equipment.



INSTRUMENT PANEL

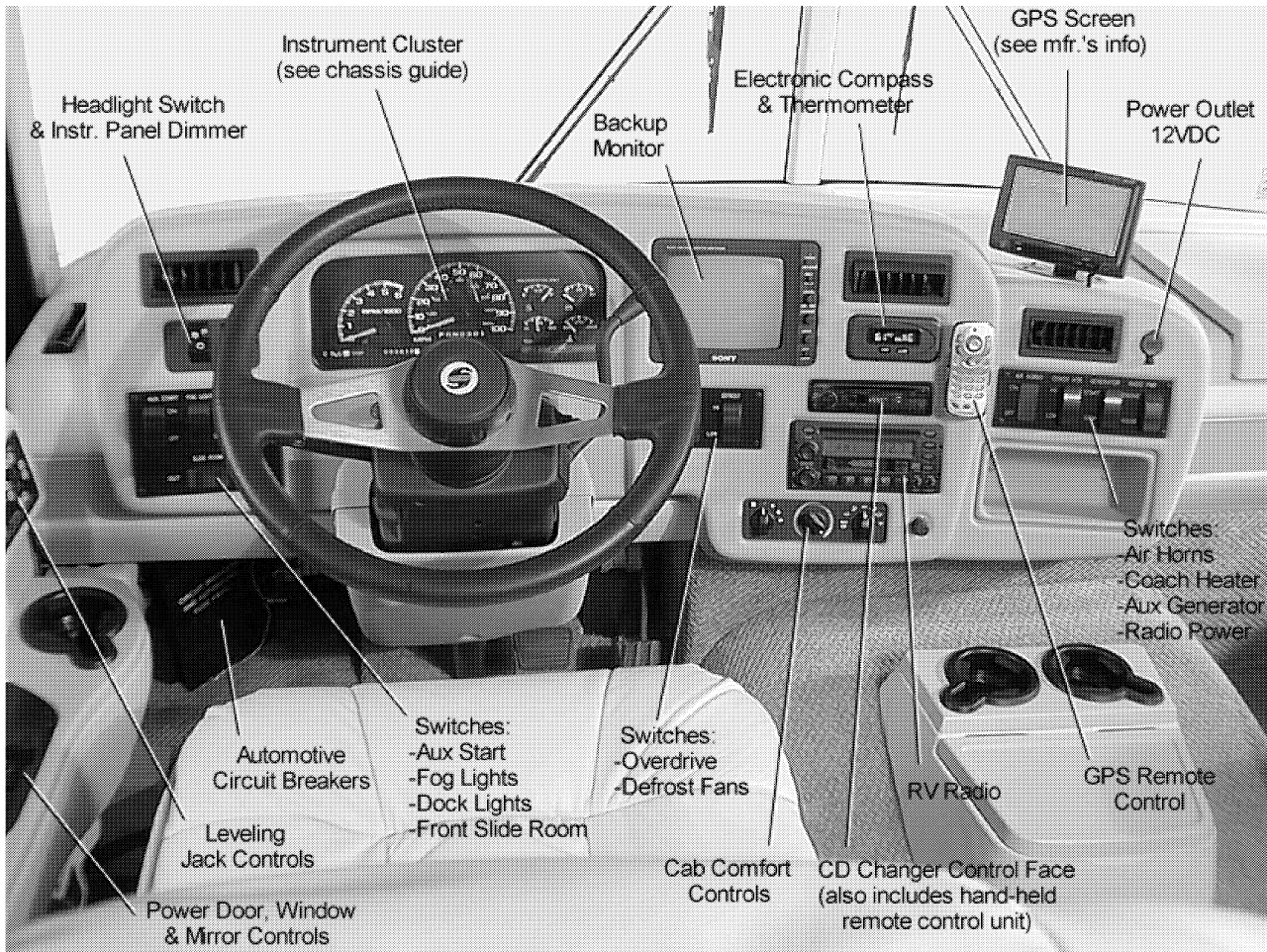

* See your Workhorse chassis operating guide.

NOTE: Some equipment or controls shown may be optional or unavailable on your model.



MULTI-FUNCTION SIGNAL LEVER

The multi-function signal lever controls the turn signals, high/low beam changing, windshield washer, wipers and wiper delay, and the electronic speed control (cruise) on some models.

See your chassis operating guide for complete operating information.



HEADLIGHT BEAM CHANGE AND TURN SIGNALS

Move multi-function lever upward for right turn signal and downward for left turn signal.

Pull end of handle toward you to switch high beam to low, or low beam to high.



WINDSHIELD WIPERS AND WIPER DELAY

See your chassis operating guide for complete operating information.

HAZARD WARNING LIGHTS

See chassis manual or "Instrument Panels" in this section for location of hazard flasher switch. See also Section 3 for further operating information.

CRUISE CONTROL

The electronic speed control (cruise) allows you to maintain a steady speed and relieve driving strain while traveling long distances.

See your chassis operator manual for complete instructions and precautions on the cruise control.

WARNING

Do not operate the cruise control on icy or extremely wet roads, winding roads, in heavy traffic, or in any other traffic situation where a constant speed cannot be maintained.



COMFORT CONTROLS

AUTO AIR CONDITIONER/HEATER

Controls for the air conditioner, heater, defroster and vent are all combined into one control panel. Refer to the following instructions for use of individual controls.

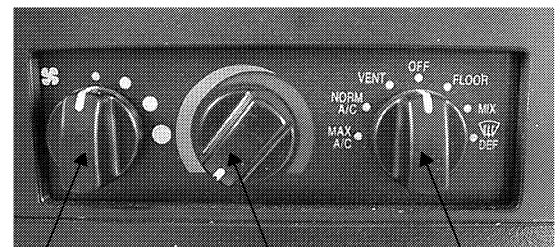

Fan Speed Control

Temp Control

Mode Selector

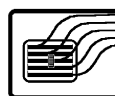

Heating

A. For maximum heating

1. Turn the temperature control knob toward the COOL (blue) zone to the desired comfort position.
2. Turn the temperature control knob to WARM (red).
3. Place the fan switch to high (largest dot).

B. For reduced heating:

1. Turn the temperature control knob to the left to an intermediate setting.
2. Adjust the fan speed for desired volume.



Defrosting

- A. For maximum defrosting and defogging:
 1. Turn the mode control knob to DEF.
 2. Turn the temperature control knob to WARM (red).
 3. Turn the fan switch to high (largest dot).
 4. Turn on auxiliary (dash) fans if additional air movement is needed
- B. For reduced defrosting:
 1. Turn the temperature control knob to the left to an intermediate setting.
 2. Adjust the fan speed for desired volume.

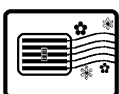

Ventilation

- A. To vent outside air into the vehicle when neither heating or cooling is required.
 1. Turn the mode selection knob to vent.
 2. Turn the temperature control knob all the way to the left to the COOL (blue).
 3. Adjust the fan speed for desired volume.



Air Conditioning

- A. For maximum cooling.
 1. Turn the mode selection knob to MAX A/C.
 2. Turn the temperature control knob all the way left to the COOL (blue) position.
 3. Turn the fan speed switch in to high (largest dot).

Off

When no heating, cooling or defrosting are required:

1. Turn the mode selection knob to OFF. This will shut off the fan and prevent outside air from entering the unit.

NOTE: The automotive air conditioner is not designed to cool the entire interior of the motor home, but is intended to cool the driver's compartment only.



AUX. COACH HEATER - Optional

To provide auxiliary heat to the coach area while driving, turn the coach heater fan switch to the desired speed. Heat will be distributed throughout the coach through the floor ducts (registers).

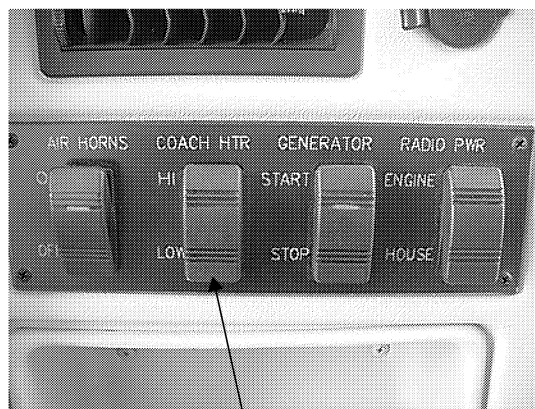

Coach Heater Switch



STEREO SOUND SYSTEM

RV Radio

The RV radio in your coach can receive AM/FM stereo and Weather band stations. It also has both cassette and compact disc (CD) players for your listening enjoyment through quality high-output speakers located in several areas of the coach.

Please refer to the RV Radio manufacturer's operating guide in your InfoCase for detailed instructions on programming preset station buttons and using this full-featured radio/audio system.

Radio Power Switch

The radio power switch lets you connect the dash radio to the coach batteries with the ignition switch turned off for listening while parked. This prevents accidental draining of the chassis (starting) battery during prolonged operation of the radio.

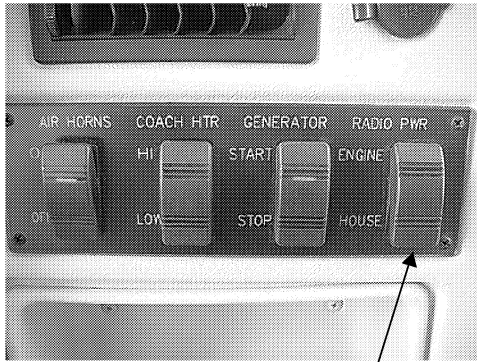

Radio Power Switch

Press "House" to listen to radio while ignition switch is off.

Deluxe Sound System (Optional)

Your coach may be optionally equipped with a deluxe sound system featuring special high-output cube speakers and subwoofers to enhance your listening enjoyment.

Place the Radio Power Switch in AUX position or the Ignition Switch in ACC position.

A speaker selector switch in the front overhead cabinet (video center) lets you switch the deluxe speakers to your desired sound source, whether the dash radio or the TV and VCR for theater surround sound listening.

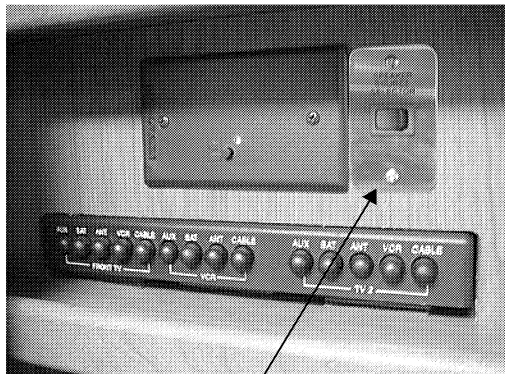

SONY COMPACT DISC CHANGER - Optional

The remote CD changer is located out of sight in the overhead cabinet above the passenger seat. The changer cartridge holds up to 10 compact discs for several hours of listening enjoyment.

The CD Changer is operated with a hand-held remote control unit, which transmits through the CD changer display face in the dash. The remote control unit is included in your Owner InfoCase. See the Sony Compact Disc Changer System operating guide in your InfoCase for complete operating instructions and basic troubleshooting.



AUX. START SWITCH

This switch can be used to provide emergency starting power from the house batteries if the automotive battery is dead.

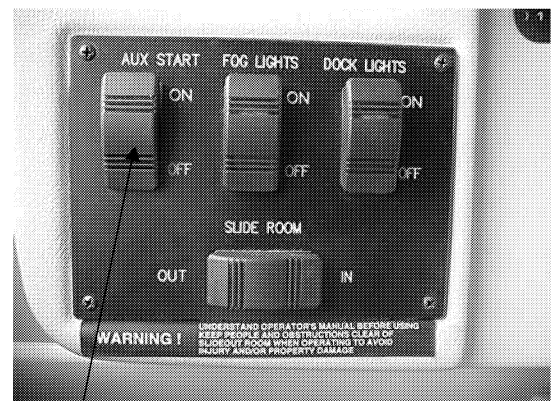

AUX START - If the engine starting (chassis) battery is dead, press the switch ON while turning the ignition key for an emergency starting boost from the house batteries.



AUXILIARY BATTERY (Aux. Batt) SWITCH

The AUX BATT switch is located near the entrance steps. It disconnects the auxiliary (house) batteries from the 12-volt system of your coach to avoid long-term battery drain by electrical items that are hooked directly to the house batteries.



Always leave this switch ON except during long storage periods (a month or more).

Passenger Work Station - optional

Pull the workstation top backward toward you until it latches in the fully extended position. There is a partitioned supply tray molded into the top of the dash beneath the worktop.

To close the workstation, release the catches on both sides of the worktop by pushing upward as shown. Glide the worktop forward until it latches onto the dash top.

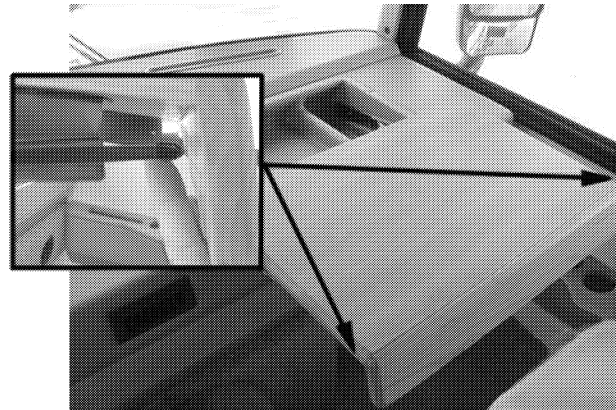

WARNING
Do not use the passenger side front workstation in the extended position while the vehicle is in motion.



CB RADIO WIRING (Optional)

If your coach is pre-wired for CB radio installation, the wires are located beneath the dash to the left of the steering wheel.

Look for a pair of wires, yellow (+) and white (-), with connectors and flag labels, suspended from the wiring harness.

Be sure to read the wire labels before installing a CB radio. The labels contain important information and cautions.



CB Wires
(in plastic sheath)



SWR ADJUSTMENT

To adjust CB antenna SWR (standing wave ratio), turn the adjusting ring of the antenna to achieve the lowest SWR reading. This procedure will help optimize transmitting and receiving capabilities of the radio system.

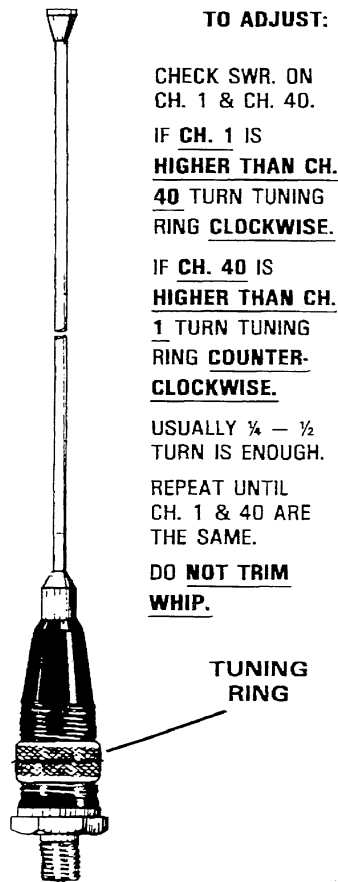

TO ADJUST:

CHECK SWR. ON
CH. 1 & CH. 40.

IF **CH. 1** IS
**HIGHER THAN CH.
40** TURN TUNING
RING **CLOCKWISE.**

IF **CH. 40** IS
**HIGHER THAN CH.
1** TURN TUNING
RING **COUNTER-
CLOCKWISE.**

USUALLY $\frac{1}{4}$ – $\frac{1}{2}$
TURN IS ENOUGH.

REPEAT UNTIL
CH. 1 & 40 ARE
THE SAME.

DO **NOT TRIM**
WHIP.

TUNING
RING

CAUTION

The CB radio could become damaged if CB antenna SWR is not adjusted before operating CB radio.

See the HWH Operator Manual in your Owner InfoCase for complete operating instructions. It also contains additional precautions, technical information, and instructions for manual operation if automatic functions fail.

The leveling system control panel is located on the driver's door panel.

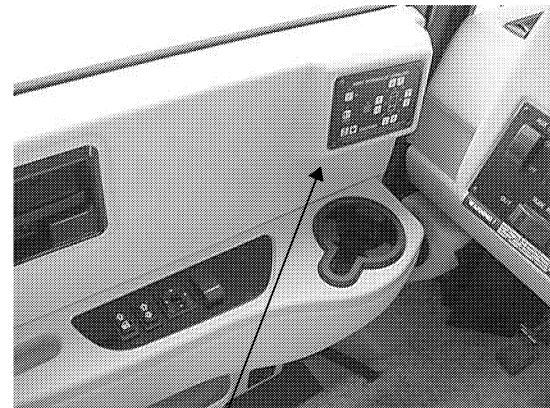

Hydraulic Leveling System
Control Panel

NOTE: When parking at an uneven site, always park the front of the motor home to the downhill side. This allows you to level by raising the front end rather than the rear. Since only the rear wheels are locked while in PARK, raising the rear wheels off the ground could allow the vehicle to roll off the jacks.

CAUTION

Do not try to drive vehicle unless 'TRAVEL' light is glowing with ignition switch on.



COACH LEVELING SYSTEMS

Your coach is equipped with a HWH® hydraulic leveling system.

This leveling system is designed to diminish problems in selecting a parking site, making "set up" easier and faster for you.

WARNING

Keep all people clear of the coach while the leveling system is operating.

Do not use leveling jacks to support vehicle for service or tire changing.



NOTE: *If one of the leveling jacks should fail to retract, it can be manually retracted by opening a valve on the hydraulic pump. The jacks are spring loaded to retract when hydraulic line pressure is relieved. See the HWH Operator's Manual included in your InfoCase for specific instructions on which valve to open and what precautions to follow. The hydraulic pump is mounted between the front chassis frame extensions just behind the front bumper of the coach.*

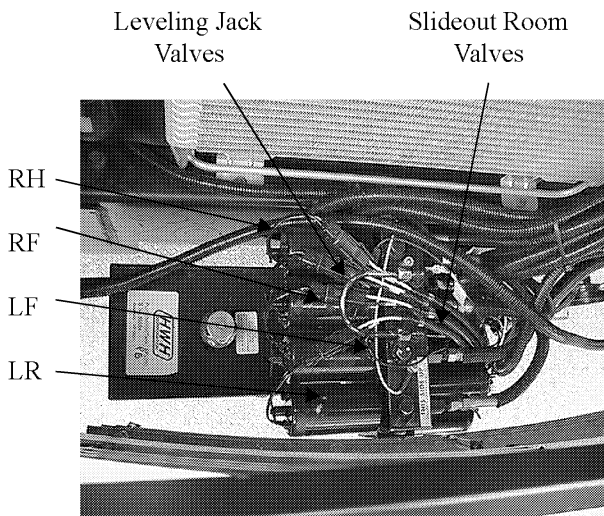

Leveling/Slideout System Hydraulic Pump
(top view from hood opening)

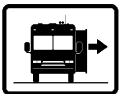

SLIDEOUT ROOM EXTENSION

CAUTION

Release slideout room travel latches before attempting to extend slideout room. Fasten travel latches before driving vehicle. See instructions below.

The slideout room extension provides a spacious living area at the push of a button. The slideout room is extended and retracted using a hydraulic mechanism with an electronic control

system. The front slideout control switch is located on the lower left dash area.

Travel Straps

The travel straps **must be released before attempting to extend the room** or damage to the coach will result.

The travel straps are designed to help keep the room extension secured against the coach sidewall to maintain an effective weather seal while the vehicle is in motion. They are not designed to withstand the force exerted by the hydraulic extension mechanism and will not prevent accidental extension of the room.

The travel latches are located near the floor at the front and rear ends of the slideout room.

To Release Straps:

- Pull the strap buckle outward and up to release tension on strap.
- Pull a short length of the excess strap back through the buckle to provide sufficient slack.
- Unhook the strap end pegs from the mooring brackets on the floor and wall edge. Store straps in location of your choice. (Under the couch is one choice.)





To Fasten Straps:

- Hook the strap end pegs into the mooring brackets.
- Flip buckle downward and press toward strap until it “snaps” snugly into place against the strap.
- If a strap is loose or too tight after closing the buckle, release the buckle and pull the loose end of the strap in or out to adjust tension as needed. Then reclose the buckle.

NOTE: If latches become loose and will not stay fastened, see your dealer for proper adjustment.

WARNING

Keep all persons clear of the slideout room and moving parts while extending or retracting. Do not occupy the slideout room while it is being extended or retracted.

To Extend SlideOut Living Room or Bedroom:

- Level the coach.
- Set the Parking Brake.
- Release travel straps.
- Press slideout power switch and hold until room is fully extended, then release switch.

Before Retracting Slideout Room

If it has rained recently before you retract the slideout room, we recommend using the hydraulic leveling system to lean the coach and drain off any excess water possibly remaining on the roof before retracting. Lean the coach slightly to the left (driver’s side) as shown by raising both right side jacks to let excess water flow away from the rooftop weatherseal and toward the outside of the slideout roof.

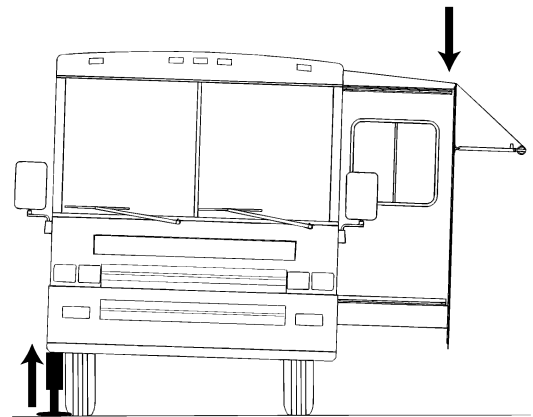

To Retract Slideout Room:

CAUTION

Although there is a cover over the roof of the slideout room, there is a possibility of debris getting onto the roof. Because the slideout roof is drawn into the interior of the coach when retracted, be sure there is no debris, such as excessive dirt, tree seeds, twigs, leaves, etc. on the roof before retracting.

- Remove all items from the coach living room floor. Turn leveling system on to provide power to the slideout control switch.
- Press slideout switch and hold until room is fully retracted, then release the switch.

High Wind Precaution

We remind you to be aware of high winds while the room is extended because of the effect they can have on the roof cover. It is a good idea to retract the room any time high wind conditions exist that would also make it necessary to roll in



the patio side awning. This will protect the slide-out room cover from possible wind damage.

If Slideout Room Will Not Operate (Troubleshooting)

- The chassis battery may be low on charge. Press the Aux. Start switch on the dash to the momentary (MOM) position while pressing the slideout control switch. This momentarily connects the coach batteries to assist in retracting the room.
- One of the fuses may be blown. Fuses are located on the interior firewall beneath the dash, beneath the instrument panel dash pod, and inside the leveling control pad housing.
- If the batteries and fuses are okay, there may be a failure in the hydraulic system or electrical system. See “Manual Retracting Instructions” for help.

**Front Slideout Room Extension
Emergency Crank-In Procedure -
(Use only when room will not retract using power switch)**

If a failure occurs in the slideout electrical or hydraulic systems, and the room will not retract using the power switch, you can manually crank the room in using an emergency winch system described below. The winch is generally stored beneath the dinette seat or in a cargo compartment on the passenger side of the coach.

Step 1 - Relieve Hydraulic Line Pressure

- Open the slideout hydraulic solenoid valves to release hydraulic line pressure and let fluid bypass into the fluid reservoir. The pump is located beneath the coach on a bracket mounted to the coach frame behind the front bumper of the vehicle. The valves can be reached best by lying on your back and reaching up between the mounting brackets, or reaching down through the hood opening.

Leveling Jack Valves Slideout Valves

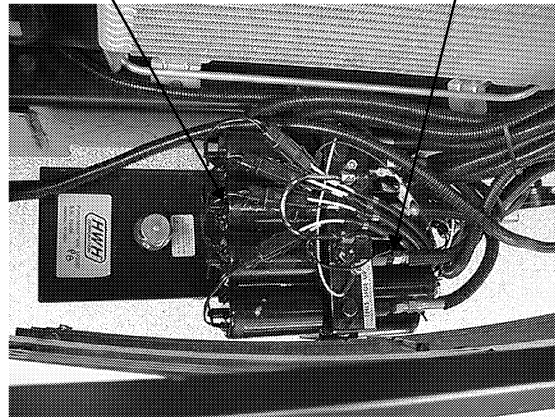

Hydraulic Pump - Slideout/Leveling Systems
(top view from hood opening)

NOTE: The hydraulic pump is equipped with two types of hydraulic solenoid valves shown. The leveling jack solenoids have a T-handle on the valve shaft that can be turned by hand. The slideout room solenoid has a small 1/4" nut at the end of the valve shaft that requires you to use a 1/4" nut driver tool that is provided in your InfoCase.

See the HWH Operator's manual included in your InfoCase for specific instructions on which valves to open for front or rear slideout rooms and what additional precautions to follow.

Turn T-handle clockwise until fully open.

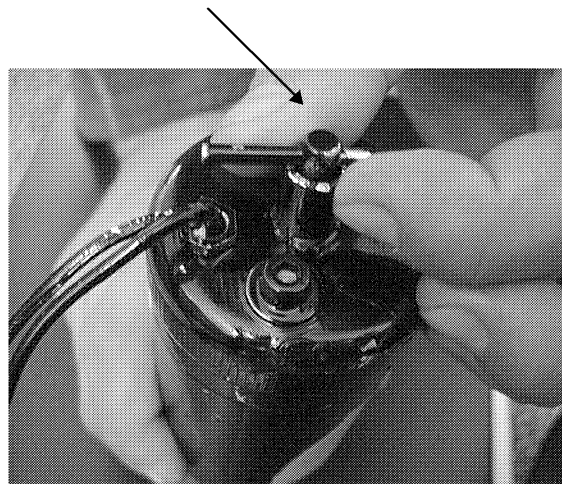

Leveling Jack Solenoid Valve



Use provided 1/4" nut driver to turn nut counterclockwise 3 turns only. (*See note)

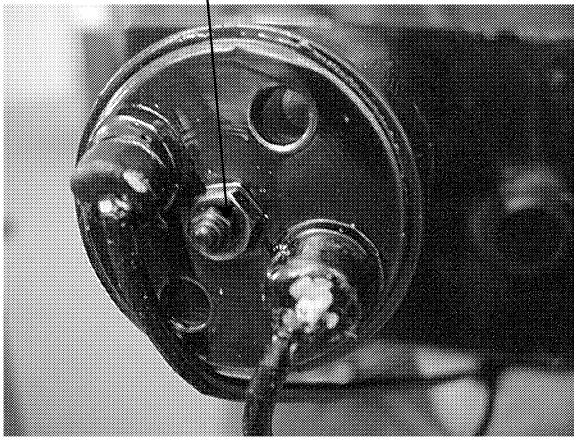

Slideout Room Solenoid Valve

WARNING

Stop engine, place transmission in park position and apply parking brake before lying beneath vehicle for this procedure.

- The hydraulic pump is located between the front frame extensions between the radiator and grille/bumper area.
- Open the two slideout solenoid valves (with 1/4" nuts on the ends) to relieve hydraulic line pressure. (See Step 1 under "Slideout Room Emergency Crank-In" on previous page.) **DO NOT LOOSEN NUTS MORE THAN 3 FULL TURNS.**
- Do not open any of the four T-handled valves on the opposite end of the pump. These regulate the coach leveling jacks.

**NOTE: The T-handles may turn easily at first but will become more difficult to turn as internal springs are compressed. Be sure to open both valves completely (about 6 turns of each T-handle).*

Step 2 - Attach Winch and Crank Room Inward

- Remove the register from the floor heat duct and anchor the winch in the floor. Insert the winch retainer bracket into the duct cutout in the floor as shown.

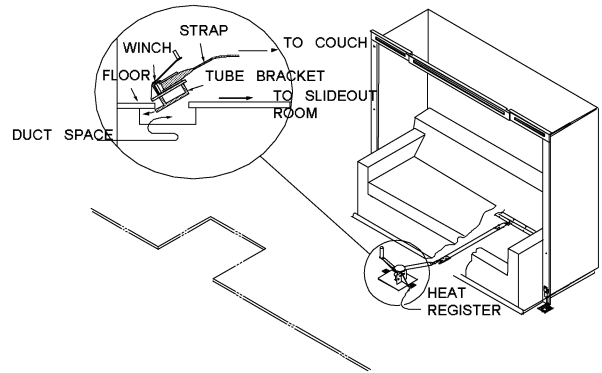

NOTE: Be sure the bracket extensions face away from the slideout room as shown for proper support while cranking.

- Insert the winch strap hook into the sewn loop end of the strap beneath the couch.
- Be sure the winch ratchet pawl is in the locking position (against the gear teeth) before cranking.
- Crank the winch handle clockwise slowly, a few "clicks" at a time, until the room is fully retracted. **Allow about 10 minutes to crank room in fully.**

NOTE: Attempting to crank the room in too quickly will raise pressure in the hydraulic fluid lines and make cranking more difficult.

- Unhook the winch and return the winch and straps to storage locations. Release the strap by putting slight pressure clockwise on the crank handle, then moving the ratchet pawl to the free-wheel position (away from gear teeth).

Step 3 - Secure Travel Straps and Close Hydraulic Line Valves

- Fasten the slideout room Travel Straps as shown on page 2-20.
- Tighten the slideout valve nuts completely.

NOTE: Close the valves snugly, but do not over-tighten. Overtightening nuts may cause internal damage to the valves.



- See your dealer for service of the room extension system before using again.

Further Information

See the HWH Hydraulic Room Extension operating guide included in your InfoCase for further instructions and troubleshooting information.

Bedroom Slideout Emergency Retraction

In the unlikely event that your bedroom slideout fails to retract using the power switch, check for obvious causes first, such as low charge on the house batteries, or a burned out fuse on the chassis fuse block. (See “Troubleshooting” on page 2-21.)

NOTE: Check fuses #16 Step Alarm and #24 Radio/Acc. There is also a fuse on the back of the HWH leveling system control pad, which must be unfastened from the driver door to inspect.

If an apparent cause is not found, call the number on your Winnebago Industries Premium Roadside Assistance card. They will dispatch a service vehicle to your location to push the room extension in so the coach may be driven to your dealer for service of the slideout control system.

NOTE: The following information may be needed by the service operator to prepare the bedroom slideout for the “push-in” procedure.

Bedroom Slideout Emergency ‘Push-In’ Procedure

- Open the “slideout” hydraulic line valves on the pump to relieve hydraulic line pressure. (See Step 1 under “Slide-Out Room Emergency Crank-In” on previous page.)
- **DO NOT OPEN THE JACK VALVES ON THE RESERVOIR SIDE OF THE PUMP.** *These regulate the coach leveling jacks.*
- Apply a steady inward pressure of approximately 150 lbs. to the exterior sidewall of the slideout room to push the room in toward the

coach until it is snug against the main coach sidewall.

- *NOTE: Use some type of rigid, padded material to protect the sidewall from punctures, dents or other damage to the finish from any device or equipment used to press the sidewall in.*
- Pressure must be applied evenly to avoid binding of the hydraulic mechanism. It may take about 10 minutes to press the room extension inward completely.
- When the room is snug against the coach wall, close the solenoid valves to prevent “creep out” during transit.
- See an authorized Winnebago Industries dealer for service of the slideout control system.



HAZARD WARNING FLASHER

The hazard warning flasher provides additional safety when the vehicle must be stopped on the side of the roadway and presents a possible hazard to other motorists. When the flasher is on, it serves as a warning to the other drivers to approach and overtake your vehicle with caution.

WARNING

Operating the hazard warning flasher system while moving on the highway is illegal.

The front and rear turn signals will flash intermittently when the flashers are in operation. When it is necessary to leave the vehicle, the flasher system will continue to operate with the ignition key removed.

See your Ford chassis operator's guide for information on operating the hazard warning flashers.



IF YOU GET A FLAT TIRE

In case of sudden tire failure, avoid heavy brake application. Tire manufacturers recommend accelerating briefly to regain steering stability, then gradually decreasing speed. Avoid quick steering movements. Hold steering wheel firmly and move slowly to a safe, off-road place. Park on a level spot, turn off the ignition, and turn on the hazard warning flasher system.

Emergency Road Service

Because of the size of this vehicle and the possible complications involved in tire changing, this coach is not supplied with a spare tire. If you experience a tire related road emergency, call the number on your Winnebago Industries *Premium Roadside Assistance* card. A tire center road service unit will be quickly dispatched to your

location to service your tire on the spot. A qualified tire center road service unit has the necessary equipment and expertise to handle road tire emergencies quickly and safely.

MOTOR HOME JACKING AND TIRE CHANGING

Information for Emergency Road Service Personnel

WARNING

We advise you to obtain qualified road service whenever possible. Do not try to change a tire yourself except under emergency conditions, and only by closely following instructions in this manual and the chassis operating guide.

If you do satisfactorily complete an emergency tire change, we recommend that you have the wheel nuts checked and properly torque tightened by qualified service personnel as soon as possible.

After a wheel has been properly torqued and inspected by qualified service personnel, it should be rechecked after traveling 100 miles, then again at each oil change.

NOTE: The jack referred to in the following instructions is not supplied with the vehicle. You can obtain one from your dealer.

A jack is designed for use as a tool for changing tires only, not for use as a leveling device or as a support when servicing.



WARNING

Tire change procedures should be used in emergency situations only. The operator is advised to obtain qualified road service when possible.

SAFETY PRECAUTIONS

Before trying to change either the front or rear tires, follow these precautions:

1. Park vehicle on level surface only.
2. Turn off engine and set parking brake.
3. Turn on hazard warning flasher.
4. Block both front and back of tire on opposite side of vehicle from wheel to be removed.
5. On soft ground, use a board or other material under jack as a firm base to ensure that the jack will not shift.

JACKING POINTS ON VEHICLE

Workhorse: See your chassis manual for specified jacking points.

FRONT WHEEL

Before trying to remove the front wheel, observe the above safety precautions, then follow the procedure below:

Removal

1. Place jack under jacking point specified by chassis manufacturer. See *Jacking Points* above. Position jack so it may be operated without placing your body beneath vehicle.
2. Screw jack extension pad out (up) until it touches jacking point surface.
3. Begin jacking until jack is firmly positioned and just begins to bear weight, but **do not** lift tire off the ground.
4. “Crack” wheel nuts loose with lug wrench, but do not unscrew nuts yet.
5. Resume jacking until wheel is free of ground.
6. Remove wheel nuts and wheel; put spare wheel in place.

Remounting

1. Remount wheel onto lug bolts.
2. Install wheel nuts and tighten as much as possible with wheel and tire off the ground.
3. Lower tire until tire just contacts the ground. Tighten nuts with lug wrench in sequence recommended by chassis manufacturer.
4. Finish lowering jack, then remove jack and blocks.

WARNING

Upon satisfactory completion of emergency tire change, it is highly recommended that wheel nuts be properly torqued and inspected by qualified service personnel as soon as possible.

DUAL REAR WHEELS

Before trying to remove the rear wheel, follow safety precautions in the beginning of the motor home jacking procedures. Then follow the procedure below:

1. Place jack under jacking point specified by chassis manufacturer. See *Jacking Points* on previous page. Position jack so it may be operated without placing your body beneath vehicle.
2. Screw jack extension pad out (up) until it touches jacking point surface.
3. Begin jacking until jack is firmly positioned and just begins to bear weight, but **do not** lift tire off the ground.
4. “Crack” wheel nuts loose with lug wrench, but do not unscrew nuts yet.
5. Resume jacking until wheel and tire are free of ground.

WARNING

DO NOT crawl under the vehicle when it is supported by a jack.

6. Remove wheel nuts and wheel.

NOTE: When installing the outer dual wheel and tire assembly, rotate the outer dual wheel so valve stems are accessible but not touching one another. In some cases this



means that the inner and outer valve stems should be in separate wheel cutout locations

NOTE: When installing or tightening dual wheels, both wheels on the same side must be off the ground (not resting on the inner dual). This minimizes the possibility of loose wheels after correct mounting torque is applied.

7. Remount spare wheel onto studs and replace wheel nuts. Refer to your chassis operating guide for wheel nut torque and tightening sequence.

WHEEL NUTS

To properly seat the wheel nuts and to eliminate the possibility of the wheel nuts becoming loosened while driving, they should be tightened at frequent intervals to the torque specified in your chassis operating guide. This is especially important after the first 100, 1,000 and 6,000 miles of operation after replacement of a wheel or wheel nuts.



RECOVERY TOWING

When calling a professional towing service, we recommend that you advise them of your coach length and approximate front axle weight. This will allow the towing operator to determine the proper towing equipment to use. (This information is found on the vehicle certification label located to the left of the steering wheel.)

We recommend that you ask for an underlift (wheel lift or frame lift) type towing assembly for safe towing.

Winnebago Industries does not assume responsibility for damage incurred while towing this vehicle.

NOTE: Consult the chassis operating guide for any additional towing instructions or precautions provided by the chassis manufacturer.

CAUTION

Do not lift on bumper. Damage will result to front end body parts.

WARNING

Stay out from beneath the motor home while it is suspended by the towing assembly unless the vehicle is adequately supported by safety stands. Do not allow passengers to occupy a towed vehicle.

NOTE: Know and obey all state and local towing regulations. Tow at reduced speed.

JUMP STARTING

WARNING

Automotive batteries produce caustic acid, explosive gases, and electrical current which may cause burns. It is important that the instructions below are followed **exactly**, or personal injury (particularly to eyes) or property damage may result due to battery explosion, battery acid, or electrical (short circuit) burns.

- NEVER smoke near the battery or expose it to open flame or electrical sparks.
- Wear eye protection or shield your eyes while working near battery, in case an explosion does occur. NEVER lean over a battery.
- Do not allow battery fluid to contact eyes, skin, clothing, or painted surfaces. Immediately flush any contacted area with water. If eyes are affected, seek medical help after flushing.
- Remove all metal jewelry to lessen the risk of a short circuit occurring.

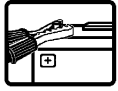

CONNECTING JUMPER CABLES

1. Make sure that the other vehicle has a 12-volt battery and negative ground compatible with your vehicle's electrical system.
2. Position the vehicle with the good battery so that the jumper cables will reach, but **do not allow the vehicles to touch.**
3. Turn off all electrical accessories, motors, and lights except those needed for safety or to light up the work area. Place automatic transmission in P (Park). Be sure parking brakes are engaged in both vehicles.
4. If the weak battery has filler caps, make sure the electrolyte is at proper level. Add distilled water if fluid is low. If electrolyte is not visible or appears to be frozen - **do not attempt jump starting!** A battery may rupture or explode if the electrolyte is frozen or not filled to the proper level.
5. Connect one end of the positive "+" (red) jumper cable to the positive "+" terminal of the weak battery. Connect the other end to the positive "+" terminal of the charged battery.
6. Connect one end of the negative "-" (black) jumper cable to the negative "-" terminal of the charged battery.
7. Finally, connect the remaining end of the negative "-" (black) cable to a solid, metal grounded location on the engine of the vehicle with the weak battery, at a point at least 18 inches from the battery. Do not connect to any moving parts. **THE MAIN SAFETY PRECAUTION IS TO MAKE THE FINAL GROUND CONNECTION ON THE ENGINE AT A SAFE DISTANCE FROM THE BATTERY. THIS HELPS TO REDUCE THE CHANCE OF EXPLOSION DUE TO SPARKS.**
8. Start the engine of the vehicle with the charged battery, and allow it to run for a few minutes at moderate r.p.m. Then start the engine of the vehicle with the discharged battery.
9. Reverse the above sequence **EXACTLY**

when removing the jumper cables. Start by removing the cable from the ground location on the engine first, then continue in reverse sequence.

WARNING

Do not attempt to push-start this vehicle. Damage to the transmission or other parts of the vehicle could occur.

CONNECTING A BATTERY CHARGER

To connect a battery charger, first make sure the engine is switched off. Disconnect the positive (+) lead from the battery. Never disconnect the battery while the engine is running or alternator damage could result.

Connect the positive "+" (red) lead of the charger to the positive "+" terminal on the battery. Next, connect the negative "-" (black) lead of the charger to a suitable ground. Finally, plug in or switch on the charger.

To disconnect the charger after charging, unplug the charger from the electrical outlets, remove the charger leads from the vehicle, and reconnect the vehicle leads to the battery.



ENGINE OVERHEAT

WARNING

Operating a vehicle under a severe overheating condition can result in damage to the vehicle and may result in personal injury.

An engine will overheat if the coolant is low or there is a loss of coolant because of one or more of the following:

- a leak in the cooling system
- a hose failure
- a drive belt breaking
- water pump failure

Also, be aware of the following situations, which can cause temporary engine overheating:

- climbing a long hill on a hot day



- idling while stopped in traffic for long periods of time
- towing a trailer or automobile
- stopping after a period of high speed driving

If the TEMP indicator on the instrument panel shows a rise in engine coolant temperature while driving, take the following steps to attempt to lower the overheating condition:

- If you are using the automotive air conditioner, turn it off.
- If you are stopped in traffic, shift the transmission into P (Park), and engage parking brake.

If the temperature does not drop within a minute or two:

- Pull the vehicle over to the roadside as soon as it is safe to do so.
- Place the transmission in P (Park) and press the accelerator to increase engine speed (r.p.m.'s) to twice that of normal idle speed, and hold it there for approximately two or three minutes.
- If engine temperature does not go down, turn the engine off and wait until the engine has cooled before attempting to open the hood.

If you see or hear steam escaping from the radiator or the engine compartment or have any other reason to suspect an extreme engine overheating condition, pull the vehicle over to the roadside as soon as it is safe to do so, stop the engine and get out of the vehicle.

When no trace of escaping steam is heard or seen, open the hood to check for the cause of the overheat. Check hose connections and tighten if necessary. Make sure there are no broken belts, pulleys or hoses before adding any coolant to the radiator.

For further information in case of overheating, consult your chassis operating guide.



(See also SAFETY PRECAUTIONS, Section 1 of this manual.)



LOADING THE VEHICLE

NOTE: *Your motor home's load capacity is designated by weight, not by volume, so you cannot necessarily use all available space when loading your motor home. See page 4-1 for more information.*

When loading the vehicle, distribute the cargo load equally so that you do not exceed either the Front or Rear Gross Axle Weight Rating (GAWR) or the Gross Vehicle Weight Rating (GVWR). The Gross Axle Weight Rating (GAWR) means the weight value specified by the chassis manufacturer as the load carrying capacity of a single axle system as measured at the tire-to-ground interfaces. This is the total weight a given axle is capable of carrying. Each axle has its own rating.

Have your vehicle weighed to determine the proper load distribution for your vehicle. Also distribute cargo side-to-side so the weight on each tire or dual set does not exceed one half of the GAWR for either axle.

For example, if the Front GAWR is 6,000 lbs., there should be no more than 3,000 lbs. on each tire. (If the left side weighs 3,100 lbs. and the right side weighs 2,700 lbs., at least 100 lbs. of the load should be shifted from the left side to the right side.) The GVWR is listed on the Vehicle Certification Label. (See page 0-3).

The total combined weight allowed for the vehicle, including trailer towing load weight, is known as the Gross Combined Weight Rating (GCWR).

NOTE: We recommend that you dump all holding tanks before traveling to avoid carrying unnecessary weight.

CAUTION

The weight of the loaded vehicle (including options, attachments, passengers, water, fuel, luggage and all other cargo) must not exceed the GVWR or GAWR of either axle.



FRONT AXLE TIRE ALIGNMENT

We recommend that you have the front suspension and steering alignment checked and adjusted after you have fully loaded the vehicle according to your needs. Thereafter, have alignment inspected periodically to maintain vehicle steering performance and prevent uneven tire wear.



WEIGHING YOUR LOADED VEHICLE

To check the weight of your fully loaded coach, locate a commercial weighing scale that is capable of weighing large trucks.

Drive the entire coach onto the scale. This weight should not exceed the Gross Vehicle Weight Rating (GVWR) specified on the Vehicle Certification Label near the driver seat. (See sample on page 0-3.)

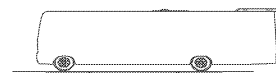

GAWR (Both axles)

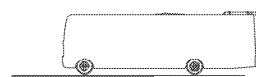

Front GAWR
(Front axle only)



Rear GAWR
(Rear axle only)



To determine the weight on either front or rear axle, drive that axle only onto the scale. Neither axle weight should exceed the corresponding maximum axle weight rating specified on the certification label.



MAXIMUM OCCUPANCY

The following label is placed in a visible location in the driver compartment.

BELTED SEATING POSITIONS MAY EXCEED SLEEPING CAPACITY OF THIS VEHICLE. SEE OWNER MANUAL FOR OCCUPANCY AND WEIGHT RESTRICTIONS.

The number of belted seating positions in your motor home may exceed the number people used to determine maximum coach occupancy, called the Net Carrying Capacity (NCC) in the U.S. or Cargo Carrying Capacity (CCC) in Canada.

To calculate the NCC or CCC, Winnebago uses vehicle sleeping capacity, however your coach may be equipped with more belted seating positions than sleeping positions to give passengers a choice of seating arrangements. You may use all of the belted seating positions providing you stay within your vehicle's GVWR listed on the Vehicle Certification Label (see page 0-3). However you use or load your vehicle, it is your responsibility to keep the weight within its stated gross vehicle weight rating.



ROOF LOADING

The roof is capable of carrying some light-weight articles while the vehicle is in motion. A roof-mounted luggage carrier designed for this purpose is available from your dealer. However, roof load while the vehicle is in motion is not to exceed 10 pounds per square foot or a maximum of 100 pounds.

When the vehicle is stationary, a cargo load of 100 pounds plus the weight of a 225 pound person to load the cargo or to conduct inspection and maintenance is permissible.

Weight added to both the roof and the trailer hitch contribute to the gross vehicle weight, which must not exceed the vehicle's GVWR.



CAR OR TRAILER TOWING

Workhorse Chassis

Hitch pulling cap:	5,000 lbs.
Tongue weight:	500 lbs. max.

The factory installed towing hitch on this coach is rated to pull a 5,000 lb. load (max.), with a vertical (tongue) weight of 500 lbs. Do not exceed either the GVWR, the rear axle GAWR, or the chassis GCWR. *See preceding items "Loading the Vehicle" and "Weighing Your Loaded Vehicle" for explanation of weight ratings.*

The combined weight of the coach and the towed vehicle should not exceed the coach's Gross Combined Weight Rating (GCWR). Also, the combined weight of the coach and the towed vehicle's hitch ball weight should not exceed the coach's Gross Vehicle Weight Rating (GVWR) or its rear Gross Axle Weight Rating (GAWR) listed on the Vehicle Certification.

Because of individual vehicle use and loading habits, we recommend weighing the vehicle while fully loaded to avoid exceeding any of the listed Gross Weight Ratings. See "Vehicle Certification Label" on page 0-3 for information on gross weight ratings.

Towing will affect vehicle handling, durability and fuel economy. Exceeding any of the listed Gross Weight Ratings will result in unacceptable overall vehicle performance. Maximum safety and satisfaction when towing depends on proper use of correct equipment. A hitch bar of appropriate steel and size should be selected to mate with the Winnebago towing receptor.

Installation of a proper trailer brake system is recommended. Check state regulations on trailer weight and trailer brake requirements to be sure you select the right equipment before towing.



NOTE: If you tow a car or trailer that weighs over 1,000 lbs., it must be equipped with automatically activated brakes. See the Towing Guidelines for Winnebago Industries Motor Homes included in your InfoCase for maximum towing capacity and GCWR for your chassis.

Before descending a steep or long grade when towing a trailer, reduce speed and shift into a lower gear to control vehicle speed. Avoid prolonged or frequent application of brakes which could cause overheating and brake failure.

WARNING

For safety towing and vehicle handling, maintain proper trailer weight distribution.

The total weight of the motor home and the vehicle towed must not exceed the Gross Combined Vehicle Weight rating. Contact the chassis manufacturer to obtain the Gross Combined Vehicle Weight rating for your chassis.

CAUTION

Exceeding any of the recommended gross vehicle weight ratings may result in vehicle damage.

Do not install a frame equalizing type hitch on your vehicle.

See also - Trailer wiring connector, page 6-10.



PRE-TRAVEL CHECK LIST

Before starting the engine to leave on a trip, be sure your motor home has been properly prepared and maintained. This will ensure an enjoyable trip and help avoid delays. Use this checklist as a guide.

- Fluid Levels - Check and fill if necessary:
 - engine oil
 - transmission

- power steering
- radiator
- brake
- battery
- windshield washer

- Wheel Lug Nuts - Check for tightness
- Tires - Check for proper cold inflation pressures as specified on the Vehicle Certification Label.
- Drive Belts - Check for proper condition and tension (not cracked, frayed, or loose, etc.)
- 110-Volt Generator (Optional) - Check oil level in generator engine.

WARNING

Never check oil level in generator while engine is operating.

- Fire Extinguisher - Make sure it is fully charged and secured in mounting bracket.
- Lights - Make sure all exterior lights operate.
- Sewer and Water Supply Hose - Unhook and store.
- TV Antenna - Make certain the TV antenna is lowered and seated in its support cradle.
- Loose Items Inside the Motor Home - Store or secure items.
- Pilot Lights - Make sure all pilots are off.
- Fuel Tanks - Check level.
- Water Tank - Fill with fresh water.*
- Exterior Door and Step - Make sure doors are closed, locked and step retracted.
- Seats - Adjusted for comfortable position and locked in place.
- Mirrors - Adjust for maximum visibility from driver's seat.

* Complete filling is not necessary in order to reduce weight while traveling, however we recommend adding enough water to flush toilet or wash hands, etc.

TRAVEL TIPS

As you travel around the country in your motor home, you will pick up useful advice from other motor home owners.

A number of suggestions can also be obtained by reading articles and regular columns in out-



door and camping magazines. Some magazines and publishing companies print an annual park and campground directory. These can be found at your local news stand or RV supply dealer. Here are a few travel tips to begin with.

1. Always check for sufficient clearance. Know the height and width of your unit.
2. Always fill the fresh water tank at an approved potable water filling facility or a known purified drinking water source. Taste the water before filling the water tank in an unfamiliar location. The water in some areas may contain an undesirable taste. Do not use a new hose to fill the water tank. It can leave a distinct rubber or vinyl taste.
3. Showers can take a lot of water. Conserve water by taking a "Sea Shower". This is done by wetting down, turning off the water, soaping thoroughly and then rinsing.
4. Dump sewage only at approved dumping stations.
5. Store liquids in plastic containers with tight fitting caps to prevent spills.
6. Keep an eye on the water and holding tank levels. It is a good idea to dump the holding tank at least every two days.
7. When traveling with children, it is helpful to plan their wardrobe for a week. Place each days clothing in a plastic bag and label the bag with the child's name and day of the week for use.
8. Use sleeping bags whenever possible. They save laundry and take up less storage space than bedding.
9. Make sure all compartment doors have been closed and the door step has been stowed in the correct position before moving the vehicle.
10. Before traveling, make sure the refrigerator door has been secured. Use care when opening the refrigerator door after the vehicle has been stopped. Any articles that have shifted may fall out when the door is opened.
11. During peak tourist season and holidays, it is best to phone ahead and make reservations at the park where you plan to stop.
12. Some states or cities will not permit vehicles with LP gas containers to pass through highway tunnels. If your route includes a tunnel, check with the highway patrol or department

of highways to avoid inconvenience.

13. Do not leave food or odor-causing material in your vehicle for extensive periods of time. Always allow damp clothing, swimwear, hunting gear, etc., to dry before stowing.
14. Become familiar with the fire extinguisher and make sure it is always fully charged. Remove and replace it and read instructions so you know the correct operating procedure before an emergency happens
15. Make a list of all groceries, fresh meats, vegetables, newspapers, etc., that you may need and try to pick them up during your last fuel stop of the day. This will prevent leaving a good parking spot once you have arrived at your destination.
16. When you sit over the front wheels while driving, as in a motor home, you have a tendency to crowd the middle of the road. Check the side view mirror frequently to observe how close you are driving to the center line.



SEVERE WEATHER INFORMATION

One of the more serious conditions affecting the motor home traveler and camper is that of the weather. Whether you travel the high mountain terrain, the lower deserts and flatland or the plains of the midwest, the weather is always with you and subject to change, sometimes with little or no warning. However, adequate warnings are normally broadcast over local radio and TV stations.

Motor home travelers and campers often seek secluded areas for weekend recreation or extended summer vacations. Many recreational areas are vulnerable to severe weather situations, especially flash flooding conditions. A few simple precautions may help lessen the hazards of flash flooding or reduce your immediate involvement.

NOTE: We recommend that all motor home occupants become familiar with these safety precautions, and be alert to change in weather.

- Be alert, because thunderstorms can form at any time, in any month of the year. Thunderstorms can produce large amounts of rain



over a small area in a short time, which may result in a flash flood. Listen frequently to weather reports on the radio for weather and flood conditions.

- When camping near a stream, leave plenty of sloping bank between you and the stream.
- Avoid deep canyons and dry washes during stormy or threatening weather. Be aware of alternate exits.
- If heavy rain occurs, move to high ground immediately (at least 30-40 feet above the canyon floor or bottom of dry wash).
- During a flash flood, if you cannot move your vehicle, abandon it. Do not attempt to return to your vehicle before the water has receded.
- Do not attempt to wade to your vehicle if the water is above your knees - fast moving water exerts an enormous amount of pressure, making it impossible to remain standing or walking.
- Do not try to drive through flooded areas.
- Follow instructions of local authorities. Leave immediately when advised to do so. Many lives have been lost because people did not heed warnings.
- Have on hand survival supplies for several days, including food, water, first aid equipment and necessary medications. In desert areas during hot weather allow 3-4 gallons of drinking water per person, per day.
- Before you leave home, inform someone of your destination and when you expect to return. Authorities at your destination should be notified immediately if you do not arrive on time.

REMEMBER THESE TERMS:

WATCH: Severe weather may develop in the specified area. Be alert and prepare for possibility of an emergency.

WARNING: Severe weather is occurring or is imminent in certain areas. Move to a safe location immediately.

We highly recommend that you obtain a weather radio. These radios offer up-to-date weather reports. The latest information and forecasts are broadcast by local National Weather Service offices in recorded messages that last from three to five minutes. These messages are replayed continually 24 hours a day. The recorded messages are revised every three to four hours, or more frequently when appropriate.

When severe weather threatens, forecasters at the local National Weather Service office interrupt the broadcasts with storm warnings, either recorded or “live” as the situation demands.

The frequencies used for NOAA Weather Radio (National Oceanic and Atmospheric Administration) nationwide are 162.40, 162.475 or 162.55 megahertz.



NIGHTTIME DRIVING

- Make sure all running lights and signal lights are clean and in working order. Have your headlights periodically checked and adjusted.
- Use care when passing other vehicles. Your motor home is a longer vehicle than a car, and you may have a more difficult time knowing when to pull back into your lane. If possible, have another person in the coach help you watch while maneuvering your motor home in traffic.



MOUNTAIN DRIVING

Special techniques must be used when driving in mountainous or hilly country.

Climbing A Hill

The transmission will automatically downshift as needed to climb most hills. If the hill is long or very steep, however, you may need to manually shift to a lower gear to keep the trans-



mission from repeatedly upshifting and downshifting. Select the lowest adequate gear range for the duration of the incline. See your chassis operating guide for more information.

CAUTION

Observe the engine temperature gauge more frequently than normal. If overheating occurs, pull off to the side of the road and allow the engine to thoroughly cool before refilling the radiator and restarting the engine.

Descending A Hill

When going down a long grade, you may need to manually shift to a lower gear, rather than keeping your foot on the brake pedal. A lower gear will allow the engine to provide a degree of braking action. Holding your foot on the brake pedal for an extended period may cause brakes to overheat, causing you to lose control of the vehicle. See your chassis operating guide for more information.

CAMPSITE SELECTION

Try to pick as level a spot as possible on which to park your motor home. Whether you nose into a parking site or back into it depends on personal preference and the location of the site's utility hook-ups. Remember that the utility connections on your motor home are on the left (driver) side of the vehicle.



LEVELING

Leveling the motor home is very important, not only for your comfort but for appliances and plumbing as well. Some refrigerators are extremely sensitive to being off level. The ammonia vapor cooling system used in most RV refrigerators can "lock-up" and damage the refrigerator if it is not level. This is both inconvenient and costly. Also, water and holding tank level indicators may give false readings because water level is greater at one side of the tank than the other.

The refrigerator is installed level at the facto-

ry. So, if the refrigerator is level, the motor home is level. A small bubble-level sight is included in the refrigerator to help you determine refrigerator leveling.

Blocking

A motor home can be leveled using several methods, including sophisticated electronic-hydraulic systems. The most common and inexpensive method, however, is "blocking."

This is done by stacking various lengths of planking (blocks) into a ramp-like formation in a low spot to drive the wheel onto, thus leveling the coach as shown.

Wedge a pair of wheel chocks or similar devices in front and back of a tire that is on the ground as shown to keep the coach from rolling forward or backward off the leveling blocks.



When placing blocks beneath a set of rear dual wheels, be sure the blocks support both tires so that the load weight is not resting on one tire, which could damage that tire.

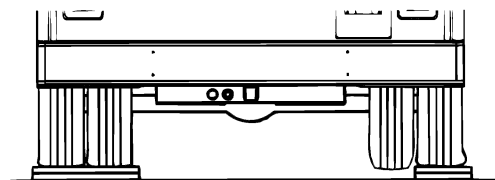

THIS

NOT THIS

Blocking Rear Duals

To provide extra firmness, you can place inexpensive mechanical jacks, jack stands or hydraulic "bottle" jacks under the frame to keep the coach from moving on the suspension springs while walking around inside the coach. These devices are not intended to lift the coach; only to hold it rigid and steady.



NOTE: We do not recommend lifting any of the wheels off the ground for leveling. This could allow the coach to roll off the jacks, possibly resulting in damage to the vehicle.

NOTE: Your coach is not designed or intended to be used as permanent housing. Using this product for long term occupancy or permanent housing may lead to premature deterioration of structure, interior finishes, fabrics, carpeting and drapes. Damage or deterioration due to long term occupancy may not be considered normal and, under the terms of the warranty, may constitute misuse, abuse, or neglect, and may therefore reduce your warranty protection.



EFFECTS OF PROLONGED OCCUPANCY

Your motor home was designed primarily for recreational use and short term occupancy. If you expect to occupy your coach for an extended period, be prepared to deal with condensation and humid conditions that may be encountered.

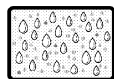

HUMIDITY AND CONDENSATION

Moisture condensing on the inside of windows is a visible indication that there is too much humidity inside the coach. Excessive moisture can cause water stains or mildew which can damage interior items such as upholstery and cabinets.

When you recognize the signs of excessive moisture and condensation in your coach, you should take immediate action to minimize their affects.

You can help reduce excessive moisture inside the motor home by taking the following steps:

Ventilate with outside air: Partially open one or more windows and a roof vent to circulate outside air through the coach. In cold weather, this ventilation may increase use of the furnace, but it will greatly reduce the condensation inside the coach.

Minimize moisture released inside the coach: Run the range hood fan while cooking, and open a bath vent while bathing or showering to carry water vapor out of the coach. Avoid making steam from boiling water excessively or letting hot water run. Avoid bringing extra moisture into the coach by way of soaked clothing or snow on shoes. Do not hang-dry wet overcoats or clothing inside the coach.



(See also Safety Precautions, Section 1 of this manual.)



LP GAS SUPPLY

The LP gas system supplies fuel for the range, water heater, furnace and refrigerator (while in gas mode). When used and handled properly, this system is safe and economical and provides modern living conveniences wherever you travel.



SAFE USE OF THE LP GAS SYSTEM

The LP system is designed and built with strict adherence to both federal and recreational vehicle industry requirements for mobile LP gas equipment.

For your safety, there are many safety devices and backup systems installed, such as tank fill overflow valves, an interior LP gas detector/ alarm, and an interior carbon monoxide (CO) detector/alarm.

LP gas also contains an odor additive that you can smell if LP is present in the air.

Listed below are a few precautions to observe that will help you to use the LP gas system safely.

- Exercise caution at all times. Be familiar with the distinctive odor of LP gas. If a leak is suspected, turn off the supply valve immediately. Have the LP gas system checked by your dealer or a qualified LP gas service center.
- Do not tamper with the LP gas piping system, pressure regulator or gas appliances. Service and maintenance of LP gas system components should be performed only by your dealer or a qualified LP gas service center.
- Never attempt to connect natural gas to the LP gas system.

- Have the entire LP gas system inspected for possible leaks and missing or damaged parts at each tank filling. Also inspect before and after each trip, and any time trouble is suspected.
- Turn the LP supply valve off when not using the LP gas system.
- Never use a wrench to tighten the tank supply valve. It is designed to close leak-tight by hand. If a wrench is required to completely close the valve, it is defective and must be replaced.
- Never allow the tank to be filled above the 80 percent level indicated by the flow of liquid gas out of the overflow valve or by the automatic stop-fill device.
- Be sure appliance and outside vents are open and free from obstruction when using the LP gas system.
- Never attach a lock or any device requiring a key to the LP tank compartment door. According to standards set for recreation vehicles, the LP supply valve must be readily accessible in an emergency.
- Exercise caution when drilling holes or attaching objects to the walls. Gas lines and electrical wiring could be seriously damaged and present an extreme safety hazard.

HOW LP GAS WORKS

LP (Liquefied Petroleum) gas is a true gas compressed into liquid form for easy transportation and storage. LP gas is available in two types - propane and butane. It is also called tank gas, bottle gas, or simply LP.

LP is used by appliances in vapor form only, but is stored in the tank as a liquid under very high pressure. As the liquid gas is released, it reverts back to a vapor and expands to many times its compressed volume.



SELECTING LP FUEL TYPES

We recommend using straight propane in your LP tank. LP gas is available in two types - propane or butane, and may be available as a butane-propane mixture.

NOTE: Many RV appliance manufacturers recommend avoiding butane or butane/propane blends. Butane burns about 30 percent hotter than propane and can overheat some appliances, particularly refrigerators, and cause permanent damage. Other appliances designed to operate on propane can become sooted and lose efficiency by using butane fuel.

Propane is commonly available in most locations. LP gas used as a motor vehicle fuel (for tractors, generators, forklifts, etc.) must be pure propane, so even in areas where butane mixtures may be sold, you can assure that you are getting pure propane by filling at an LP refilling station that sells motor fuel LP. Check local phone directory yellow pages for these LP gas refilling stations.

Butane is typically sold only in warmer climates and is not normally sold in northern states. See also *Winter Use of LP Gas* on page 5-5.

LP GAS OUTPUT

Each gallon of liquid LP gas contains approximately 92,000 BTU's of heat energy; or about 36.2 cubic feet of dry gas for cooking, heating, water heating and refrigeration.

To find out how long a gallon of LP gas will last, you should determine the total BTU **input** on all your LP gas appliances in use. Let's say you have a furnace that has a 10,000 BTU **input** per hour of operation. A gallon of LP gas would last 9.2 hours of continuous operation (92,000 BTU's ÷ by 10,000 BTU's = 9.2). To estimate how long a gallon of LP gas lasts, try to determine what your total daily BTU input is, then divide into 92,000 to arrive at an approximate daily LP gas consumption.

LP TANK SYSTEM

The storage reservoir for the LP gas system is a horizontally mounted tank which is permanently attached to the vehicle frame. The tank is accessible only from the outside of the vehicle. The tank supply valve is located near the top center of the tank, next to the regulator. Before opening the supply valve, check to be sure all controls for gas appliances are in the "Off" or "Pilot Off" position. If this step is not performed, LP gas could accumulate inside the motor home creating a fire or explosion hazard.

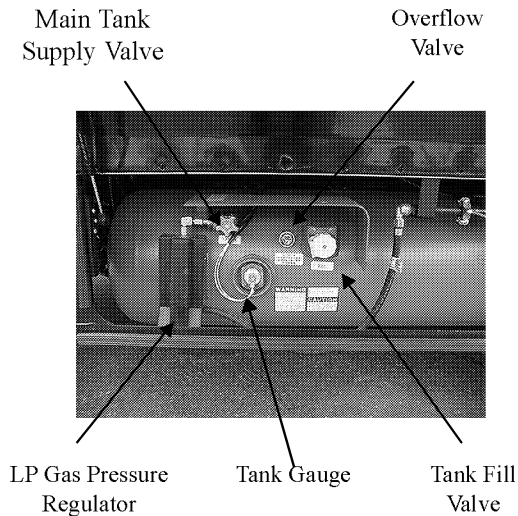

LP Gas Tank Capacity:

LP Gas Tank Capacity: *23 gal.
(28 gal.w.c.)

*LP Gas tank capacity shown is the usable "full" LP gas capacity, which is 80% of the tank manufacturer's listed water capacity (w.c. shown in parenthesis). An LP tank must have at least 20% of tank volume free to allow for expansion and proper vaporization of the liquid fuel. The tank is also equipped with mandatory safety shut-off equipment that prevents filling above this level.



REFILLING LP TANK

There are many LP gas refueling stations located throughout the country. These stations are listed in the telephone directory Yellow Pages under "Gas - Liquefied Petroleum - Bottled and Bulk."

Since the LP tank is permanently mounted to the frame, the motor home must be taken to an LP dealership for filling. Do not attempt to remove the LP tank from the vehicle. The tank is equipped with a fill adapter with both internal and external threads which allows easy filling with any LP filling equipment. The tank is full when liquid LP gas appears at the overflow valve.

NOTE: The LP tank is equipped with an automatic 80% stop-fill device.

WARNING

Make sure the filling attendant uses the 80% overflow valve when filling the tank. A tank should never be filled above 80% level to allow for vaporization and liquid expansion.

Do not place LP gas containers inside the vehicle. LP gas containers are equipped with safety devices which relieve excessive pressure by discharging gas to the atmosphere.

Do not place LP gas containers, gasoline, or other flammable liquids inside the vehicle. Fire or explosion may result.

AIR IN THE LP GAS TANK

If your LP gas appliances do not stay lit or require frequent adjustment, even though you know the LP tank contains sufficient fuel, the problem may be air in the LP gas tank. Air in the tank mixes with the LP gas vapors causing them to burn poorly. This condition could linger for weeks if the air is not purged from the tank. Most LP gas dealers have equipment for purging air from LP gas tanks and will purge before refilling the tank.

TRAVEL WITH LP GAS

It is illegal for vehicles equipped with LP tanks to travel on certain roadways or through certain tunnels in the U.S. To avoid inconvenience, check state regulations concerning flammable gas transportation.

WARNING

Do not alter or remove LP tank gauge at any time.

WARNING

DO NOT FILL CONTAINER TO MORE THAN 80 PERCENT OF CAPACITY. Make sure the motor home is level when filling. It is possible to accidentally overfill the tank if the vehicle is unlevel, with the fill valve on the uphill side. Overfilling the LP gas tank can result in uncontrolled gas flow, which can cause fire or explosion. A properly filled container will contain approximately 80 percent of its volume as liquid LP gas.

All pilot lights must be extinguished and supply valve closed before refilling LP gas tanks or vehicle fuel tanks.

Do not smoke or expose an open flame while near an LP refueling area. LP gas is heavier-than-air and extremely flammable.

Never use an open flame to test for LP gas leaks.

Replace all protective covers and caps on LP system before filling.

Never fill the LP tank with engine or generator running.

REGULATOR

The pressure regulator is protected from the elements by a plastic cover which should be left



in place at all times. Only your dealer or a qualified LP gas service should remove the regulator cover for adjustments.

WARNING

Inspect the pressure regulator vent hole periodically for blockage. If any obstruction is apparent, have the regulator serviced by your dealer or a qualified LP gas service center.

LP gas regulators are installed with the diaphragm vent facing downward. Make sure that the regulator vent always faces downward to minimize vent obstruction which could result in excessive pressure, causing a fire or explosion.

Regulator freeze-ups are caused by the presence of moisture in fuel. This moisture will pass through the cylinder valve and into the regulator where it can freeze. Fuel producers, tank and bottle manufacturers and LP gas dealers take every precaution to reduce moisture, but sometimes only a fraction of an ounce entering the tank can cause problems. To help avoid the possibility of freeze-up, always keep tank control valve closed when not in use, even when tank is empty, to prevent moisture from collecting on the inside.

If regulator freeze-up should occur, you may attempt to thaw the regulator using a light bulb. **DO NOT USE AN OPEN FLAME OR HEAT LAMP.**

Be sure vent hole is not blocked

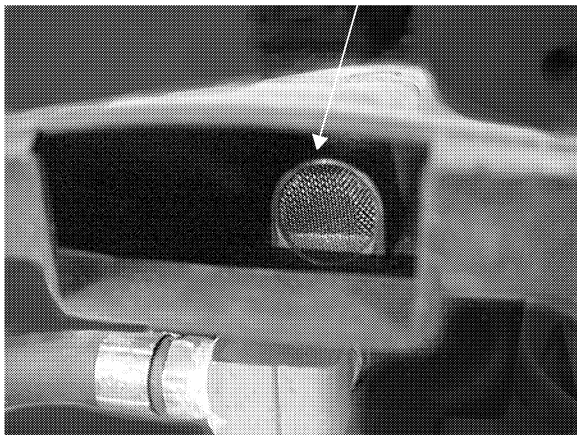

If moisture begins to cause problems, have your LP gas dealer inject a small amount of dry methyl alcohol in your tank (approximately one ounce to 20 pounds or one pint to 100 gallons) to help guard against regulator freeze-ups.

In very cold weather when a large volume of gas is being used for heating, it is possible to experience a loss of gas pressure. At first, this problem may appear to be caused by a regulator freeze-up, but is actually caused by failure of the liquid gas to vaporize as fast as it is needed. As the temperature becomes colder, it is increasingly harder for the liquid LP gas to vaporize. At the same time, the demand for LP to produce heat increases to the point where the system cannot maintain production.

The only solution to this problem is to reduce the consumption of gas where possible. Adjusting the temperature on the gas/electric refrigerator may be a first step. Using less hot water will help as well.



LP GAS LEAKS

The following label has been placed in the vehicle near the range area. If you smell gas within the vehicle, quickly and carefully perform the procedures listed.

IF YOU SMELL GAS

1. Extinguish any open flames, pilot lights and all smoking materials.
2. Do not touch electrical switches.
3. Shut off the gas supply at the tank valve(s) or gas supply connection.
4. Open doors and other ventilating openings.
5. Leave the area until odor clears.
6. Have the gas system checked and leakage source corrected before using again.

LP GAS ALARM - See page 1-3.



WARNING

Never use an open flame to test for gas leaks. When testing for gas line leaks with a soapy water solution, DO NOT use a detergent containing ammonia or chlorine. These substances may generate a chemical reaction causing corrosion to gas lines, resulting in dangerous leak conditions.

<u>Temperature</u>	<u>Percentage of BTU's Available at 0° F.</u>
20° F.	200%
10° F.	150%
0° F.	100%
-5° F.	75%
-10° F.	50%
-15° F.	25%
-20° F.	12 1/2%
-44° F.	Propane will not vaporize



WINTER USE OF LP GAS

Due to vaporization characteristics of LP gas, it is important that the winter camper knows how to most efficiently use the LP system. The vaporization rate of LP gas decreases in a direct relationship to a decrease in temperature. Propane will convert to a usable gas temperatures down to -44°F. For this reason, propane is a popular heating fuel in cold climates. However, even propane vaporizes at a slower rate as it becomes colder.

The greater the amount of liquid gas in the tank (up to 80% level) the greater the amount of LP gas vapor generated. The following is an example of the number of BTU's available from an 84-pound tank at 0° F at three levels. As you can see, the number of BTU's decreases as the tank is emptied. Nearly twice as many BTU's are available from a full tank than one that is one-fourth full.

BTU's Available at 0° F.	
<u>Tank Level</u>	<u>BTU's</u>
80%	64,000
50%	50,400
20%	33,000

The following LP Gas Vaporization and Temperature Relationship chart typifies the LP gas loss with a decrease in temperature. The percentage figures are the increase or decrease of vapor that would be available at 0°F. These figures apply to any size LP gas tanks.



(See also Safety Precautions, Section 1 of this manual.)

Your motor home is equipped with an electrical system consisting of two separate voltages; a 12-volt DC system and a 110-volt AC system. The 12-volt system consists of two internal power sources, while the 110-volt system is operated from an outside power source or the optional 110-volt generator.

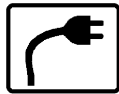

110-VOLT AC SYSTEM

The 110-volt system operates from an outside 110-volt utility service such as those at campgrounds, or from the optional 110-volt generator. When the power cord is connected to an outside power source, or when the generator is in operation, the power converter automatically changes a portion of the 110-volt current to 12-volt DC current. All equipment in the motor home that is normally powered by the auxiliary battery is then powered through the converter.

In addition, the following equipment is entirely dependent on the 110-volt generator or shoreline connection: air conditioner, refrigerator (when placed in 110-volt mode), microwave oven, and other 110-volt electrical equipment used at convenience outlets.



EXTERNAL POWER CORD (Shoreline)

The external utility power cord (commonly referred to as a “shoreline”) is stored in the utility compartment on the left (driver’s) side of the coach.

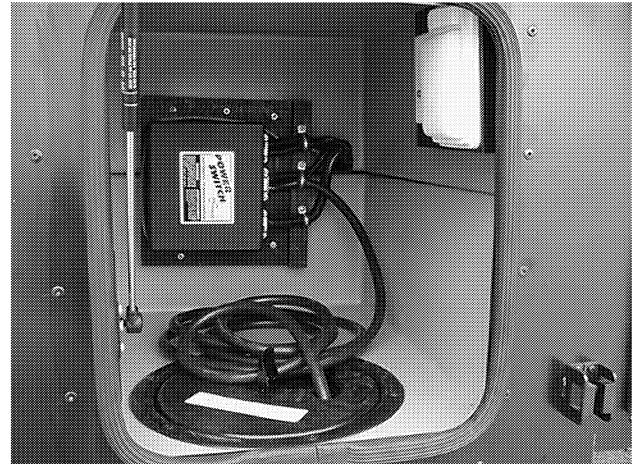

Shoreline Cord Compartment

WARNING

Do not connect the external power cord to any receptacle **until** you have contacted the owner and/or attendant of the premises to verify proper polarity and grounding.

It is the responsibility of the owner of the electrical receptacle to ensure that the receptacle is properly wired and grounded.

Reverse polarity and improper grounding of the vehicle can cause personal injury or death

The power cord is designed to ground the electrical system through the receptacle. It is also designed to carry the amperage output of most campground outlets. If the electrical receptacle to be used is designed to mate with the prongs on the power cord plug, the electrical connection can be expected to carry rated load.

Your coach is equipped with 50-amp shoreline service.

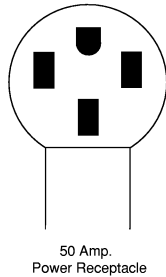

The 50-amp shoreline gives your coach extra current handling capacity.

NOTE: Some parks do not have 50-amp service available, so you may need to connect to a standard 30-amp service pole using an adapter, available from your Winnebago Industries dealership or most RV supply stores.

WARNING

Do not plug the power cord into an outlet which is not grounded, or adapt the plug to connect to a receptacle for which it is not designed.

Be sure that all the prongs of the supply cord are properly plugged into the receptacle.

Do not connect the power cord to an extension cord.

Park Fuses or Breakers

Most campgrounds are equipped with a fuse or circuit breaker at the receptacle. This protects the park's wiring, as well as the power cord on your vehicle, from electrical damage. If electrical power fails, contact the park attendants and have them check the fuse or breaker for your supply receptacle.

After disconnecting the power cord, neatly replace it in the storage compartment.

POWERLINE ENERGY MANAGEMENT SYSTEM (EMS)

The energy management system (EMS) monitors the electrical usage of the appliances

and equipment in the coach and distributes the electrical loads to avoid nuisance tripping of the shoreline circuit breaker. This system works together with the energy efficient TrueAir central air conditioner to allow you to run both cooling compressors at the same time on a 30-amp shoreline connection.

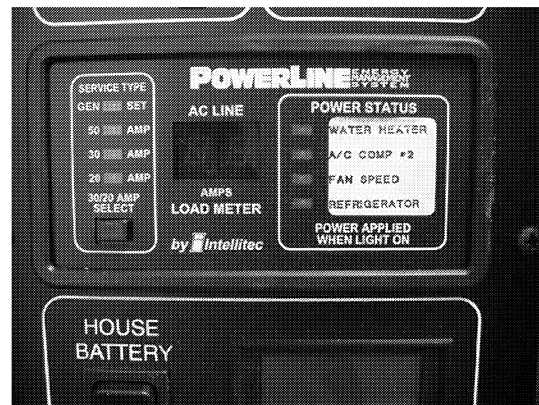

EMS Display on OnePlace Monitor Panel

Please read your Power Line Energy Management System Owner's Guide for important information on running both front and rear roof air conditioner units at the same time. This guide will also explain how this system operates under several conditions, whether 20-amp, 30-amp or 50 amp connections.

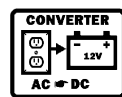

POWER CONVERTER SYSTEM

The power converter changes 110-volt AC current from the auxiliary generator or the shoreline into 12-volt DC current for use by 12-volt equipment in the motor home.

Certain circuits, however, remain unchanged for use by items which require 110-volt current, such as the air conditioner(s), the refrigerator in AC mode, the microwave oven, etc.

Current drawn from the coach batteries passes through the power center unchanged, although it is routed through a series of protective circuit breakers located on the house 12-volt and 110-volt breaker panels.



NOTE: The converter will not change 12-volt DC current to 110-volt AC.

If your coach is equipped with a DC-AC power inverter, the converter does not function while the inverter is being used.

WARNING

Do not store anything around or on top of the converter, or in front of the cover. The converter generates heat while operating, and needs unrestricted air flow for proper cooling.

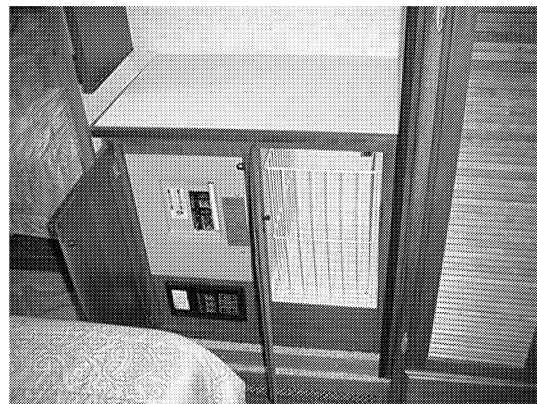

House 110-Volt Breaker Panel
in Bedroom Closet

Power Converter and Circuit Breaker Locations

The converter system is made up of individual components located in various parts of the coach.

- **House 12-Volt Circuit Breaker Panel:** behind small cabinet door below refrigerator; contains pop-out circuit breakers



House 12-Volt Breaker Panel

- **110-Volt Breaker Panel:** behind cabinet door inside bedroom closet.

110-Volt Circuit Breakers

The breaker panel protects all 110-volt components in the motor home from either an overload on the circuit or a short in the wiring or component itself. When an overload or short develops, the breaker will open preventing any further flow of electricity and, therefore, damage to the system.

Shut off the equipment (example: air conditioner) and allow a brief cooling period. Then reset the breaker by moving the switch to “Off” and back to “On”. If the breaker is continually tripped and no overload is evident, have the system checked for a short in the wiring or the appliances.

Charging Section

The converter charges house batteries while 110-volt external power is connected. The converter will automatically “sense” the condition of the RV battery. If it is below “full charge”, the Charging Section will start charging the battery.

If the house batteries have been extremely discharged, they will accept charge at a relatively high amperage rate. If they are only slightly discharged, they will charge at a lower amperage rate. The rate of charge will decrease as the batteries reach “full charge”, then will remain “trickle” charging at a very low amperage rate. If your storage battery does not charge as described above, it is possible the battery is defective.



Converter Overload Protector

The converter overload protector will shut-down the converter if it becomes overheated. This can result from operating above its maximum limit for an extended period of time or by obstruction of ventilation to unit.

NOTE: When the converter is not operating, 12-volt lights and motors will draw power from the house batteries.

The converter overload protector will reset itself after a cool-down period. The lights and motors will resume operating from the converter. If the overload protector trips again shortly after reset, take immediate steps to correct cause of overheating. A portion of RV 12-volt load (lights or motors or both) should be turned off to reduce total load. Also, inspect power converter section to make sure ventilation is not obstructed.

NOTE: The converter will not change 12-volt DC current to 110-volt AC.

Further Information

Refer to the converter manufacturer’s information provided in your InfoCase for additional information about your power converter system.

INVERTER/CHARGER AND CIRCUIT BREAKER LOCATIONS

- **2000W Inverter/Charger Unit:** The inverter/charger is located on the forward wall of the battery compartment. The inverter/charger has a power/reset switch and two circuit breakers to protect the inverter and the AC input source from overloads. See the Heart Interface operation information for complete explanation and instructions on this system.

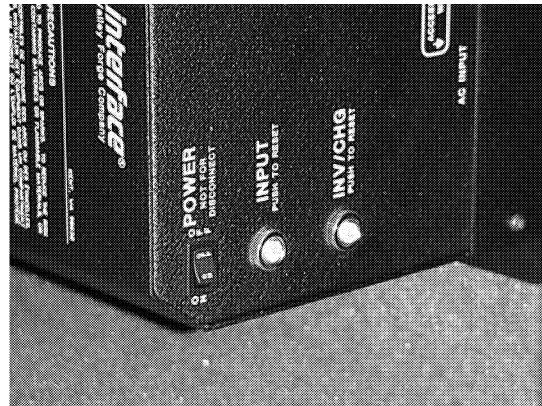

CAUTION
Do not store items too closely around the inverter unit in the storage compartment. The inverter generates heat while operating and needs unrestricted airflow for proper cooling.

- **Inverter Control Panel:** The Heart Interface inverter/charger also has a remote monitor/control panel that can be programmed for several charging configurations. See the Heart Interface remote panel instructions in your Owners InfoCase for complete information and specific configuration directions.

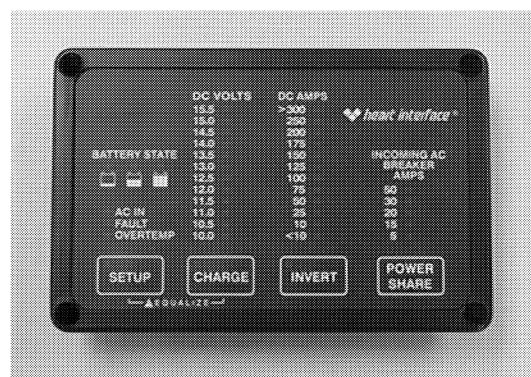

Inverter Charger Control Panel

- **12-Volt House Circuit Breakers:** The 12-volt house breaker panel contains pop-out breakers; push in to reset. The breakers are clearly labeled for the circuits which they protect.

The House 12-volt Breaker Panel is located behind a cabinet door near the microwave oven, refrigerator, or washer/dryer, depending on model.



House 12V Breakers

**Typical view of breaker panel. Actual breaker labels may vary according to appliance and equipment options. Fuses and breakers are labeled on panel.*

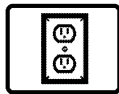

110-VOLT RECEPTACLES (Outlets)

A number of standard AC electrical outlets are provided throughout the coach for connecting small appliances such as televisions, radios, toasters, etc. Outlets are also located on the outside of the coach near the entrance door.



GROUND FAULT CIRCUIT INTERRUPTER

Exterior, bath and galley outlets are connected to a GFCI (Ground Fault Circuit Interrupter), which is an extremely sensitive circuit breaker that will help to protect against severe electrical shock if a ground fault develops. If such a condition occurs, the GFCI will break the circuit by turning off the power to the protected outlets. Should this occur, unplug all the appliances on

that circuit and press the reset button on the GFCI equipped outlet.

If the GFCI keeps tripping, have the electrical system checked and repaired if necessary before using again.

The GFCI outlet is located in the bath, bedroom or dinette area, depending on the floor plan of the vehicle.

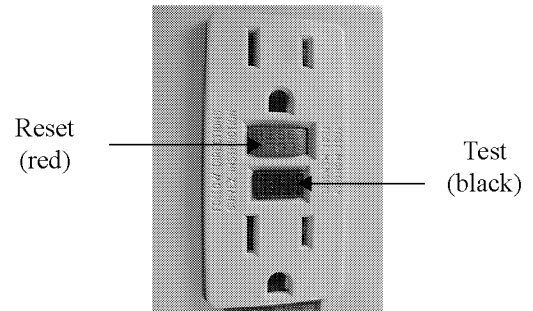

WARNING

The GFCI will not completely eliminate electrical shock. Small children and persons with heart conditions or other disabilities which make them especially sensitive to electrical shock may still be injured by a 110-volt receptacles even though protected by a Ground Fault interrupter.

NOTE: In compliance with CSA electrical codes, the appliance outlet in Canadian equipped coaches is not connected to a GFCI protected circuit.

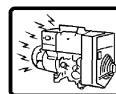

AUXILIARY 110-VOLT GENERATOR

Consult the generator manufacturer's information provided in your InfoCase for instructions on operation, troubleshooting and maintenance.

This coach may be equipped with one of several models of generators. Consult the generator owner's manual in your InfoCase for specific instructions on starting and stopping your generator



NOTE: Gasoline powered generators draw their fuel from the main chassis fuel tank. After extensive generator use, you may notice decreased level in the fuel tank.

WARNING

Careless handling of the generator and electrical components can be fatal.

Never touch electrical leads or appliances when your hands are wet, or when standing in water or on wet ground.

Do not attempt to repair the generator yourself. Service should be performed by an authorized service center.

Do not plug the power cord into the generator receptacle while the generator is running.

Automatic Power Transfer Switch

Your coach electrical system is equipped with an automatic power transfer switch. The transfer switch is normally connected to the shoreline cord.

When the generator is started, the transfer unit will switch the power feed to the generator after 20 seconds. The twenty-second delay is to allow the generator to start easily without an electrical load.

When the generator is shut down, power is automatically switched back to the shoreline cord.

STARTING AND STOPPING THE GENERATOR

This coach may be equipped with one of the several models of generators. Consult the generator owner's manual in your InfoCase for specific instructions on starting and stopping your generator.

Basic Generator Operation:

Starting:

For your convenience, generator switches are located on the dash, on the OnePlace panel, and

on a nightstand cabinet in the bedroom as well as on the genset unit itself in the generator compartment. The generator starter circuit does not rely on the automotive battery, so the switch will operate whether the ignition switch is on or off.

- See generator manufacturer's operating information for specific instructions.
- Reduce all electrical loads. (Shut off lights, fans, appliances, etc.)
- If the generator has not been run for two weeks or more, you may need to prime the fuel system before attempting to start.
- Press the generator starter switch on and hold until generator engine is running, then release.

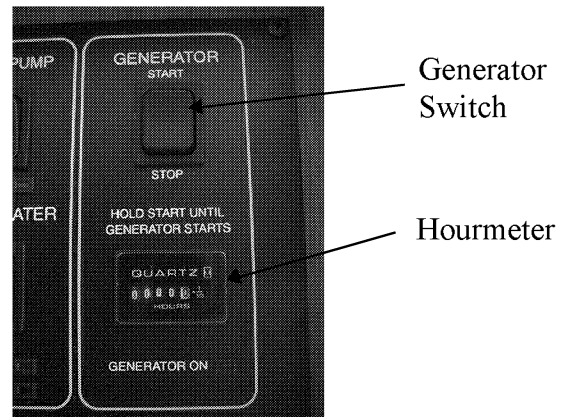

- Let the generator engine stabilize and run smoothly before turning appliances or electrical equipment on.
- Do not overload generator by turning too many items on. Overloading will cause the circuit breaker on the generator to trip. If this happens, the generator will run but no electricity will be present in the coach. You must then reset the circuit breaker on the side of the generator.
- Refer to the output specifications of your generator in the generator manufacturer's manual. Then see the following electrical load chart to estimate your typical loads.

Stopping:

- Before shutting generator down, turn off electrical loads and let engine run at no-load for a few minutes to cool down.



- Press the generator switch Off and hold until the generator engine comes to a complete stop.

CAUTION

Continuous generator overloading can cause high operating temperatures that can damage the generator windings. Keep the electrical loads within the generator wattage ratings.

Approximate Power Requirements of Common Appliances	
Appliance or Tool	Approximate Power Consumption (Watts/Amps)
Vacuum cleaner	200-500W/1.7-4.3A
Coffee Maker	550-700W/4.8-6.1A
Hair dryer	800-1500W/7.0-13.0A
Electric clothes iron	500-1200W/4.3-10.4A
Electric blanket	50-200W/0.4-1.7A
Television	80-100W/0.7A
Electric drill	250-750W/2.2-6.5A
Air conditioner	1400-2000W/13-19A
Converter	300-500W/2.6-4.3A
Microwave Oven	700-1500W/6.0-13.0A

GENERATOR HOURMETER

This meter is located on the monitor panel. (See photo on previous page.) It registers the total number of hours that the generator has been operated. Refer to the hourmeter to determine when periodic maintenance is due and to record services which have been performed.

GENERATOR OPERATION WARNINGS AND CAUTIONS

WARNING

The exhaust of all internal combustion engines contains carbon monoxide (CO). This poisonous gas is colorless, odorless, tasteless, and lighter than air. The exhaust systems of both your motor home engine and your generator engine have been installed with your safety in mind. However, certain precautions must be taken when using them to protect yourself from conditions beyond the control of the manufacturer.

1. **Do not** simultaneously operate the generator engine and a ventilator which could draw exhaust gases into the vehicle.
2. **Do not** open windows or ventilators on the end or side of the vehicle where exhaust pipe of the generator is located.
3. **Park the vehicle** so that the wind will carry the exhaust away from the vehicle. Also, note the position of other vehicles to be sure their exhaust will not enter your vehicle.
4. **Do not** operate the generator engine when parked if vegetation, snow, buildings, vehicles, or any other object can deflect the exhaust under or into the vehicle.

Check auxiliary generator oil level frequently during periods of use. Refer to the generator manufacturer's information in your InfoCase for specific recommendations.

WARNING

Never check generator oil level while generator engine is running.



12-VOLT DC SYSTEM

The DC voltage system consists of the chassis battery and the 12-volt auxiliary batteries.



Chassis (Starting) Battery

The chassis battery is used solely to operate the engine starter and all automotive accessories and controls found on the instrument panel. This includes the horn, speed control, all exterior lights, radio, windshield wipers, rear auto heater fan, etc.

House Batteries

The house batteries supply current to all 12-volt equipment located in the living area of the motor home. This includes interior lights, range exhaust fan, furnace fan, water pump, water level and holding tank gauges, 110-volt generator starting, refrigerator and bath roof vent fan. The house battery may also be used to start the engine if the automotive battery is dead. Refer to “Aux. Start Switch.”

The house batteries are automatically charged by the engine alternator when the engine is running.

House 12-Volt Circuit Breakers

All 12-volt circuits and equipment in the coach (house) area of the motor home are protected by a circuit breaker panel. When a circuit is overloaded or a short develops in any part of the system, a breaker will shut down that circuit. If this happens, turn off all affected lights or appliances and reset the breaker.

A label on the panel states the amperage rating and circuit protected for each breaker.

The house breaker panel is mounted behind a small door, below the refrigerator.



House 12-Volt Breakers

12-Volt Automotive Circuit Breakers and Fuses

The 12-volt automotive circuit breakers and fuses are located on a panel on the firewall beneath the left side of the dash, ahead of the driver’s left foot while seated in the driver seat. To remove the protective cover, turn the twist lock to the left, then pull the cover outward and up.

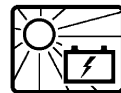

SOLAR CHARGER PANEL

The 10-watt roof-mounted solar charger panel uses the sun to help keep your batteries charged. A charger indicator light is located on the OnePlace monitor panel in the galley area near the dinette table and thermostat or range hood monitor panel.

The light will glow red when the solar panel is charging the coach batteries. The greater the rate of charge, the brighter the light. When the batteries reach full charge the light will gradually dim, then darken.

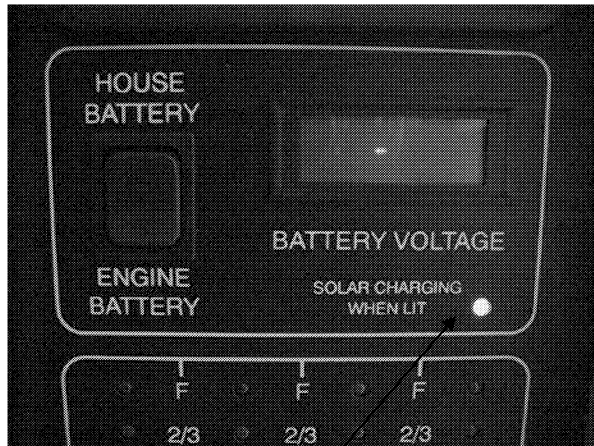

Solar Charging Indicator

NOTE: The solar battery charger is not intended to make the coach battery system “maintenance free.” The solar panel will not completely compensate for continuous low amperage draw from components such as the LP gas leak detector, the clock in the bedroom radio and the radio station memory circuitry, for example. Although the solar panel system can help to extend battery life, the coach shoreline should be plugged in routinely to “top off” the batteries. We also recommend following regular battery inspection and maintenance, especially in cold weather.

See your dealer for proper installation.

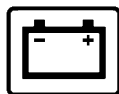

BATTERY INFORMATION

The coach batteries are “deep-cycle” type batteries specially designed for recreational vehicle use. They will provide longer lasting power than standard automotive batteries, and will withstand the frequent drain-and-recharge cycles that occur under the demanding conditions of a camping outing.

BATTERY ACCESS - Model 36W

This model has a slide-out tray in a battery compartment on the outside of the coach.

BATTERY ACCESS - Model 39T

The batteries are located beneath the entrance steps. Unhook the latches fastening the steps and remove.



Squeeze lock tab upward and pull latch handle outward



Lift step to access batteries

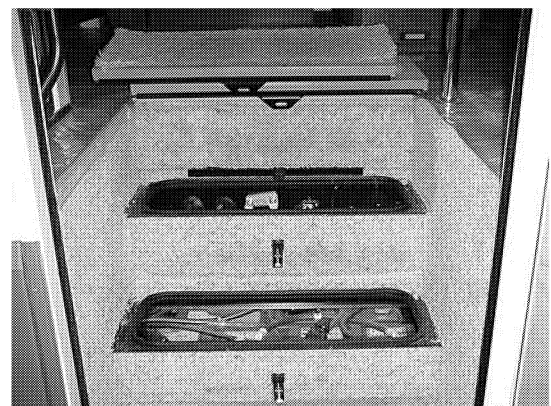



BATTERY MAINTENANCE

Lead -acid type batteries are electro-chemical devices for storing and releasing electrical charge. As such, they are simply an electrical reservoir, not an electrical source. As soon as energy is removed from the battery, it should be replaced by the engine alternator or the RV converter system.

If a battery sits unused for 30 days or more, especially during warm weather, it can develop a deposit of sulfate crystals on the metal plates inside the battery. This condition is called sulfation or sulfating, and prevents the battery from either releasing or accepting a charge. If this condition occurs, the battery must be replaced.

If a battery does not contain at least 80% charge during freezing temperatures, the electrolyte can freeze and crack the battery case.

The two best defenses against sulfating and insufficient charge are to:

- 1) turn off the Auxiliary Battery switch to avoid parasitic discharge (the trickle discharge caused by directly connected components like LP gas detectors or digital clock displays in the range hood or radio, etc.), and
- 2) check the battery and recharge as necessary at least once a month during long storage periods.

Turn the Aux. Batt. Switch off to avoid electrical arcing when attaching or detaching charger clamps.

NOTE: We do not recommend leaving the shoreline plugged in continuously during storage periods because the batteries can lose electrolytic fluids and become damaged from continuous charging without periodic use. We recommend following regular battery inspection and maintenance, especially in cold weather.

WARNING

California Proposition 65 Warning: Battery posts, terminals and related accessories contain lead and lead compounds, chemicals known to the state of California to cause cancer and reproductive harm. Wash hands after handling.

Futher precautions are:

- Remove the battery from the coach.
- Store it in a cool place on a wooden or rubber pad to inhibit conductive transfer.
- Check the state of charge periodically to avoid discharge or sulfating.
- Make sure the batteries always remain securely clamped in the battery tray.
- Make sure battery cable clamps are tight on the terminal posts and are free of corrosion.
- Neutralize corrosion buildup or acid film on top of battery by washing with a baking soda/ water solution. Rinse with clear water.

NOTE: Make sure vent caps are on securely to prevent baking soda solution from entering the battery and contaminating the electrolyte fluid.

WARNING

Before removing any battery cables or battery, make sure all 12-volt equipment in the motor home is off and the power cord has been disconnected.

Replace any damaged cables at once. Always remove jewelry and wear protective clothing and eye covering when checking or handling batteries.

- Clean and tighten battery terminals and have the specific gravity checked at least once a year.
- Every two months, or more often in hot weather, check the battery fluid level. If nec-



essary, fill with distilled water to approximately 3/8 inch above the plates. **DO NOT OVERFILL.** If water is added during freezing weather, either charge the battery or drive the motor home several miles to mix water and electrolyte to prevent freezing.

- Fluid level check may be omitted if equipped with maintenance-free batteries.

WARNING

To prevent wiring damage, it is essential when replacing the cables on the battery, or when using a “booster” battery, that the positive post and the positive cable be attached and the negative post and negative cable be attached. The posts are marked (+) plus and (-) minus. If a “fast charger” is used while battery is in the motor home, disconnect both battery cables before connecting the charger. Never attempt to charge or boost a frozen battery.

BATTERY CONDITION METER

See related item under “Monitor Panel” in section 8, Appliances.

AUX. START SWITCH

See section 2, Driving Your Motor Home for information on Aux. Start Switch.

TRAILER WIRING CONNECTOR

Your coach is pre-wired for trailer or car towing lights with a 6-pin socket on the rear bumper. The connector plug is supplied in the coach parts package provided to you by your dealer when you took delivery of the vehicle.

The diagram shows proper connection of trailer or tow vehicle wiring to the coach light system. Remove the small screw near the end of the plug and slide the contact assembly out of the barrel.

TM = Tail lights
GD = Ground
LT = Left Turn
RT = Right Turn
S = Brake Lights
A = Backup Lights

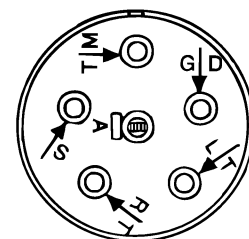

**NOTE: On Ford chassis, these turn signal connection also include a brake light function.*

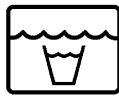

FRESH WATER SYSTEM

The fresh water system provides water to the galley sink, shower, bathroom lavatory, toilet and water heater. Water may be supplied by either of two sources:

- a water tank located within the motor home, or,
- any external water source to which the motor home may be connected by hose, known as “city water”.



Fresh Water Tank Capacity: 70 gal.

FILLING THE FRESH WATER TANK:

Always fill the fresh water tank at an approved potable water filling facility or a known purified drinking water source.

You can fill your water tank using either of two methods; gravity fill or city water pressure fill.

Gravity Fill: Insert hose into fill opening and turn water supply on. Tank is full when water flows from overflow tube beneath coach. The gravity fill tube is located behind a small, lockable door on the exterior right (passenger) side-wall.

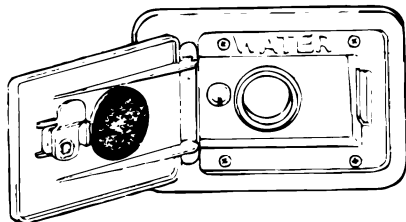

Water Tank Fill*

To Pressure Fill Water Tank from City Water Connection:

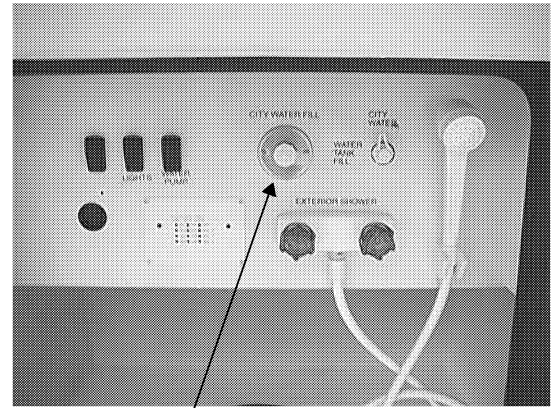

City Water Connector

1. Attach a hose from a city water faucet to the city water connector in the water center.
2. Turn the water center diverter valve to the WATER TANK FILL position as shown in following photo.



3. Open city water faucet. (See subsequent NOTE for pressure regulator recommendation.)
4. Tank is full when water begins to flow from the tank vent tube beneath the coach.

NOTE: Because city water pressure varies from location to location, we recommend using an in-line water pressure regulator to prevent damage to any components, connections and seals in your fresh water system.



A water pressure regulator may be obtained from any well stocked RV dealership retail center and some retail discount centers. These devices simply connect in-line between the supply hose and the city water input on the coach.

*We recommend a regulator that controls water pressure to **40 psi maximum**.*

NOTE: *Be sure to open the gravity fill door to prevent pressure build up while filling the tank from the city water connector.*

NOTE: *Always keep the tank fill valve pointed to “City Water” unless you are filling the tank. If this valve is pointing to “Water Tank Fill” while using city water, the water will keep flowing into the tank and out the tank vent tube.*

ing the first few used of the water pump system. Thereafter, remember to check it at least yearly, such as during winterization procedures.

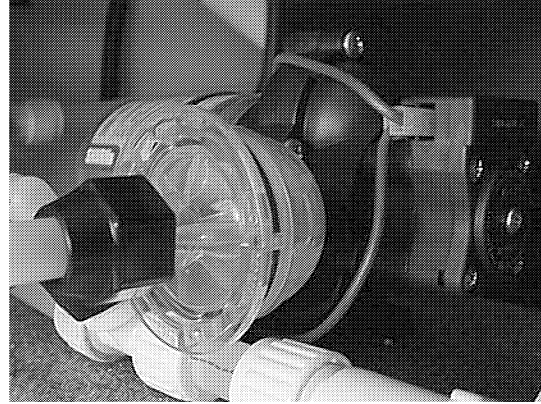

Water Pump and Filter



Fresh Water Tank Capacity: 70 gal.



WATER PUMP

When your coach is not connected to a city water supply, water is supplied from the fresh water tank by a water system demand pump. A demand pump is designed to run only when a faucet is turned on and shut off soon after the faucet is turned off. When you turn a faucet on, the pump will begin to run and it will continue to run as long as the faucet is open.

The pump is self-priming and will run briefly to build up line pressure when the Water Pump Switch is first turned on. See “Initial Water Line Priming” for instructions on using the water system for the first time after a storage period or if the tank and water lines have been drained.

Pump Strainer Filter

The pump is equipped with a cleanable strainer filter to capture any possible tank borne particles that could damage pump components.

NOTE: *We recommend that you check and clean this filter after each tankful of water dur-*

To Clean Pump Strainer

- Push the flat inlet cap in towards the rounded bowl section and twist counterclockwise about 1/4 turn to disengage from locking tabs.
- Remove the cap, then pull the strainer out of the bowl to tap out any particles and rinse clean.
- Insert the strainer back into the bowl, then twist the cap back into the bowl assembly to close.

Water Pump Switch

Your coach is equipped with water pump switches in three convenient locations:

- on the OnePlace monitor panel (See section 8)
- in the bathroom
- in the exterior shower compartment on the outside of the coach (See page 7-5).

Initial Start-Up

1. Make sure that all water drain valves are closed, including water heater valve. (Refer to Section 10.)
2. Turn water pump switch to “OFF” position.
3. Fill water tank.
4. Open all faucets, hot and cold.
5. Turn on pump switch.
6. Close each faucet as it begins to deliver a steady stream of water (close cold water



first). Leave hot water faucets on until they also deliver a steady stream of water. This will ensure that the water heater is filled with water.

7. Check to be sure pump stops soon after all faucets have been closed.
8. Pump is now ready for automatic operation. Pump will start when a faucet is opened and stop when the faucet is closed.

ACCUMULATOR TANK

A pressurized accumulator tank is installed in the water line directly upstream from the water pump located in the rear compartment on the driver or passenger side of the coach.

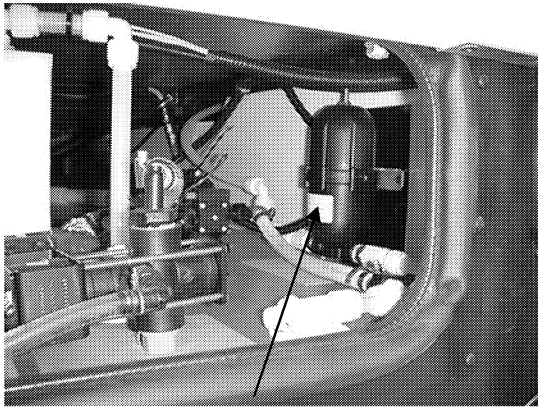

Water Pressure
Accumulator Tank

The accumulator tank holds a small amount of water under pressure of 20 psi to reduce water line pulsation noise and pressure variations when using the water pump system. This also contributes to longer pump life, less pump cycling, and less amperage draw by the water pump from the coach batteries.

NOTE: The accumulator tank has a precharge pressure which must be checked monthly and maintained at 20 psi for the system to work properly.

Adjusting Precharge Pressure

A tire-type valve stem is provided on the end or top of the accumulator tank to check or add air pressure.

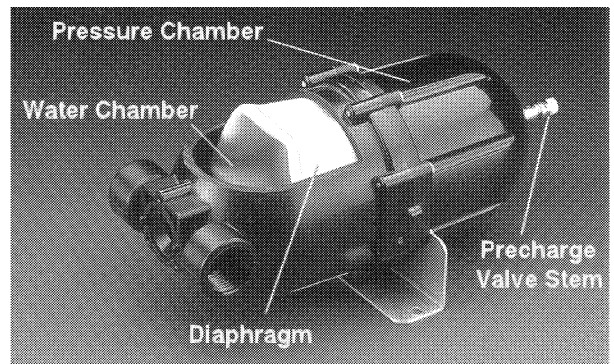

When adding air, do not exceed 20 psi tank precharge pressure because you may risk rupturing the pressure bladder inside the accumulator tank. Before checking precharge pressure, drain the accumulator tank by turning off the water pump and opening a faucet to drain off water line pressure. Because of the relatively small capacity of the bladder, check pressure with a standard tire pressure gauge before adding air, then if necessary, add air in small bursts, checking pressure between each burst until 20 psi is attained.

Overfilling will also push the bladder too far and reduce the volume of water held in the accumulator tank, making the system inefficient.

The precharge valve stem cap **must be tight** to prevent pressure leak-down.

Further Information

See manufacturer's information supplied in your InfoCase for complete maintenance instructions and precautions.



EXTERNAL WATER SUPPLY ("City Water")

To connect to an external source:

1. Turn the demand pump switch to Off. Also be sure fill valve is turned to "City Water" as shown



2. Attach a hose from the external water source to the city water connection in the utility compartment on the left side of your vehicle.
3. Turn on the city water faucet.

When connected to an outside source of water, the water bypasses the demand pump and storage tank and supplies pressure directly to individual faucets and toilet.

NOTE: Always keep the tank fill valve pointed to "City Water" unless you are filling the water tank. If this valve is pointing to "Water Tank" while using city water, the water will keep flowing into the tank and out onto the ground through the tank vent tube.

A passage or hatch is provided in the bottom of the compartment to route the hose through so you can close the compartment door during use.

A hose elbow, available from most RV suppliers, may be added (see photo) to avoid kinking the city water hose when the compartment door is closed.

To disconnect from the external source:

1. Turn the external source off.
2. Open a faucet inside the vehicle to relieve line pressure.
3. Disconnect the hose from the coach.
4. Replace the protective plug back into the threaded collar on the connection.

DISINFECTING FRESH WATER SYSTEMS ON RECREATION VEHICLES

(As approved by the U.S. Public Health Service)

To assure complete disinfection of your fresh water system, it is recommended that the following procedure be followed on a new system, one that has not been used for a period of time, or one that may have become contaminated. This procedure is also recommended before long periods of storage such as over winter.

1. Prepare a chlorine solution using 1 gallon of water and 1/4 cup of household bleach (sodium hypochlorite solution). With tank empty, pour chlorine solution into the tank. Use 1 gallon solution for each 15 gallons of tank capacity. This procedure will result in a residual chlorine concentration of 50 ppm in the water system. If a 100 ppm concentration is required as discussed in item 3, use 1/2 cup of household bleach with 1 gallon of water to prepare the chlorine solution. One gallon of the solution should be used for each 15 gallons of tank capacity.
2. Complete filling of tank with fresh water. Open each faucet and run the water until a distinct odor of chlorine can be detected in the water discharged. Do not forget the hot water taps.
3. Allow the system to stand at least 4 hours when disinfecting with 50 ppm residual chlorine. If a shorter time period is desired, then a 100 ppm chlorine concentration should be permitted to stand in the system for at least 1 hour.
4. Drain and flush with fresh water.

WARNING

Chlorine is poisonous - recap bottle and clean utensils after use.

Never use automotive type antifreeze in your potable water system as it is poisonous.



WATER PURIFIER SYSTEM

The water purifier system uses a flow-through activated carbon filter that removes chlorine and other impurities, resulting in clean, taste-free and odorless drinking water.



Water Filter Assembly -
Below Galley Sink

Replacing the water filter cartridge:

Replace the filter cartridge when water flow from the purifier faucet is too slow for convenience.

- Place a container beneath the filter to catch any remaining water during removal.
- Raise the valve handle then twist the filter cartridge counterclockwise about a quarter-turn and pull it down and out of the filter head.
- Insert a new water filter cartridge up into the filter head as far as possible and turn it clockwise a quarter-turn.
- Lower valve handle to lock filter in place.

See “Winterizing the Water Purifier System” in Section 10.

SHOWER HOSE VACUUM BREAKER

After using the shower, you may notice water dripping from the shower faucet assembly. The dripping results when vacuum in the shower hose (after closing the shower faucet) slowly releases and allows water remaining in the hose to drain down. This is a normal function of the shower valve assembly and is not a leak or defect.

The International Association of Plumbing and Mechanical Officials Standard TSC 21-85 (PAR. 4.3) states:

“Shower heads which incorporate shutoff valves, shall have a minimum “drip rate” of one (1) quart in thirty (30) minutes.”

CAUTION

If items are placed into the shower tub before shower valve vacuum release is complete, they may become wet.

The label shown below is attached on or near the faucet to explain the operation of the vacuum breaker assembly.

For your protection, this faucet is equipped with a vacuum breaker (back flow preventer) to prevent contamination of your potable water supply. The water in the hand held shower hose will drain through this vacuum breaker when the faucet is turned off. This is not a leak. This drainage is inherent in the design of the vacuum breaker, and is evidence that it is functioning properly.

P.P.I. 0387

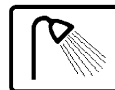

EXTERIOR SHOWER

The exterior auxiliary shower feature allows you to do things such as rinse off sand or salt after a swim, rinse off muddy boots, or bathe your pet outside the coach. It is located in the utility system compartment.

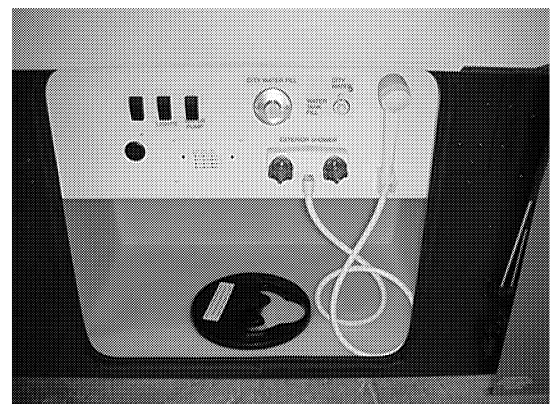



For your convenience, a water pump switch is located near the shower knobs. This allows you to turn the pump on or off from outside the coach.

The exterior shower also doubles as a water line drain valve. See drain valve locations on page 7-8 for further information.



WASTE WATER SYSTEM (HOLDING TANKS)



The drainage system is self-contained and uses two separate holding tanks to contain the waste water until it can be dumped at an appropriate waste water disposal site. This means you can use the toilet, sinks and shower even in areas where utility hookups are not available.

The main holding tank contains the sewage from the toilet, and is commonly called the *black water tank*. The second holding tank contains the waste water from the galley sink, bathroom lavatory and shower, and is commonly called the *gray water tank*.

The holding tanks are dumped through a common outlet located inside the water service compartment on the left side of the coach.

NOTE: The dump valve spout can be swiveled downward or upward for routing the hose out the bottom hatch while connected to on-site waste disposal, or out the side door when dumping at a public dump station.



DUMPING HOLDING TANKS

1. Remove drain hose from exterior storage compartment.
2. Remove dust cap from drain and connect drain hose. Be sure it is firmly attached.
3. Place the other end of sewer hose into disposal opening.
4. Open the black water valve with a quick pull and make sure there are no sags in the hose. Move the hose gently about to dislodge any waste and ensure complete drainage. Close black water valve as soon as tank is empty.

NOTE: Do not open the gray water valve until the black water tank is drained and dump valve closed to avoid sewage back-up into gray tank. Gray water also rinses any black water solids from the drain hose.

5. Open the gray water valve. Be sure there are no sags in the hose to ensure complete drainage. Close gray water valve as soon as tank is empty.
6. After both tanks have been drained, run several gallons of water into the sewage tank through the toilet. Then open sewage dump valve and drain the tank again. Close valve and replace dust cap securely.
7. It is advisable to add an odor control chemical to the sewage holding tank. These chemicals are available at most R.V. stores.
8. Rinse sewer hose thoroughly with water and stow.

NOTE: We recommend that you dump all holding tanks before traveling to avoid carrying unnecessary weight.



Flushing your Black Water Holding Tank

The black water holding tank is equipped with an internal flushing head to allow you to rinse the inside of the tank with clean water after dumping.

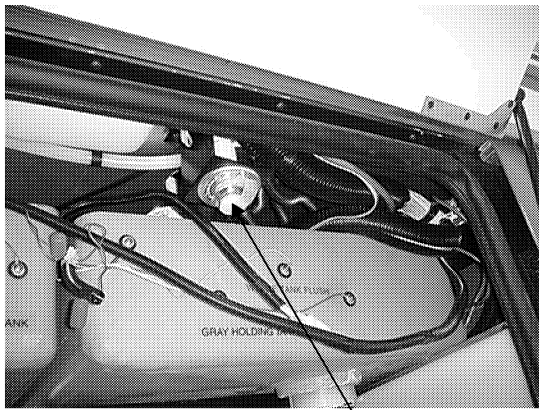

Black Water Tank
Flush Fitting

1. Dump your black water holding tank in the usual manner at approved sewage disposal station.
2. Leave black water dump valve open while flushing tank.
3. Attach a garden hose from a city water hydrant to the Flushing System fitting near the black water dump valve. (This inlet is clearly marked separate from the City Water inlet.)
4. Turn the water on to begin flushing; allow water to run for about three minutes.
5. Disconnect hose from flushing system fitting and close dump valves.

USING ON-SITE SEWER HOOK-UPS

The drain hose may remain attached to the dump outlet and be routed out the bottom of the compartment while the motor home is parked and connected to an on-site sewage hook-up.

When using a sewer hook-up, keep the dump valves closed until a tank becomes full or when preparing to leave the site. This keeps the solids in suspension, allowing them to be carried out with the liquids when the dump valve is opened. If the valve is left open, the liquids will drain off, leaving solids in the tank. Should this accidentally happen, disconnect the hose, fill the tank about half full with water, and drive a few miles to dislodge the solids. A few starts and stops will aid in the process. Then reconnect the hose and drain in the normal manner.

UTILITY LIGHT

A lamp is located up on the left sidewall to provide light in the utility hook-up area.

The switch is located inside the utility system compartment on the left side of the coach.

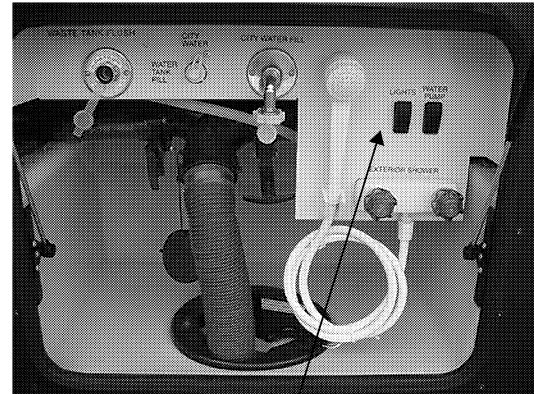

Utility Area
Light Switch

HOLDING TANK LEVEL INDICATORS

The holding tanks may be monitored on the OnePlace wall mounted monitor center and on the panel in the water center.

Press the "Levels Test" switch to check the level in each tank.

See pages 8-8 for further information on the monitor panel.

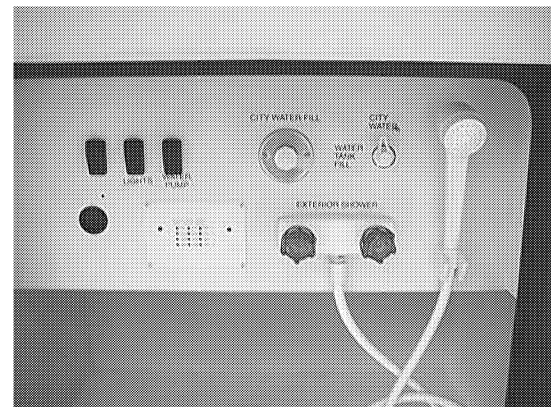

WATER DRAIN VALVES

The water drain valves are used to drain water from the water tank and the water supply lines



SECTION 7
PLUMBING SYSTEMS

when preparing the motor home for storage or when sanitizing the water system.

To open or close the drain valves, turn the handles in the directions indicated by the following illustration.

Drain valve locations are listed on the following pages.

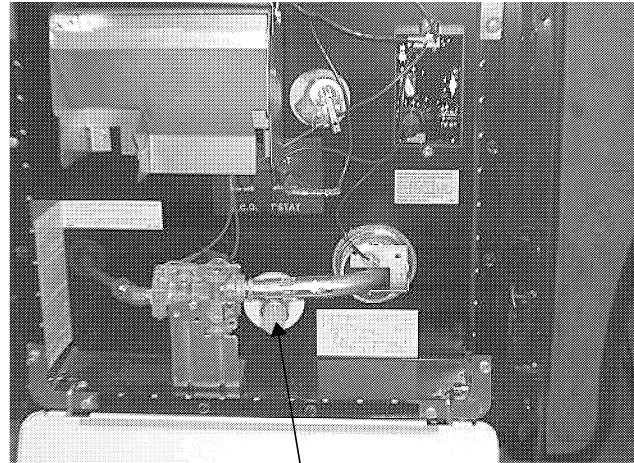
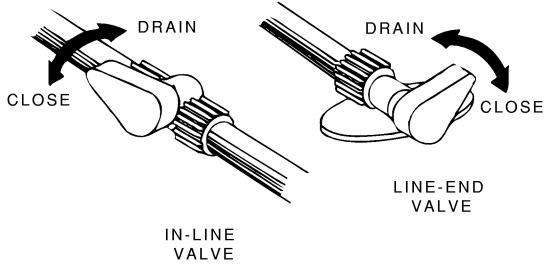

Water Heater
Drain Plug



Water Tank
Drain Valve

Water Line
Drains
& Winterization



TANK CAPACITIES



Black Water Holding Tank

Model 39C, 39L, 39T	48 gal.
Model 36W	45 gal.



Grey Water Holding Tank (Galley, Shower & Lavatory)

Model 39C, 39L, 39T	58 gal.
Model 36W	67 gal.

WATER SYSTEM DRAIN VALVE LOCATIONS

MODEL	SYSTEM	DRAIN VALVE LOCATIONS
36W	Water Lines:	Hot and Cold water lines: Two (2) valves near the water pump in the front cargo compartment on the passenger side of the coach. Open exterior shower faucet valves and lay shower head on ground to drain exterior shower line.
	Water Tank:	One (1) large yellow handled valve near water tank in passenger side front compartment.
	Water Heater:	Drain plug on outside of coach, behind service door. Use socket to remove drain plug.
	Water Heater By-Pass Valve:	Located near the water tank in the passenger side front cargo compartment.
	Manual Winterization (Antifreeze) Valve:	In the front cargo compartment on the passenger side of the coach.
39T 39L 39C	Water Lines:	Hot and Cold water lines: Valves located near the water pump in drainage compartment above LP tank on passenger side of coach.
	Water Tank:	Large yellow handled valve in drainage compartment above LP tank on passenger side of coach. Turn the valve handle inline with the drain tube to open. Close valve as soon as tank is drained to prevent airborne contaminants or entry by rodents or insects.
	Water Heater:	Drain plug on the water heater, behind water heater service cover in front right cargo compartment. Use socket to remove drain plug.
	Winterization (Antifreeze) Valve: manual	Valve with clear siphon tube locate near the water pump in drainage compartment above LP tank on passenger side of coach.



(See also Safety Precautions, Section 1 of this manual.)

NOTE: Because this model is available in several sizes and floor plans, some items described may be optional or unavailable on your coach.

The appliances installed in your motor home are manufactured by reputable RV appliance makers and have been tested by independent laboratories to meet all applicable standards and codes set for RV appliances. These appliances are covered by your New Vehicle Limited Warranty. (Certain items may be covered by individual manufacturer's warranty.) See your New Vehicle Limited Warranty for details.

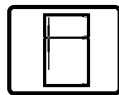

REFRIGERATOR

The refrigerator in your coach can be operated from either of two power sources available to the motor home:

- 110-Volt AC electric
- LP gas

The refrigerator is an absorption type which uses an ammonia-water solution for cooling. Basically, ammonia vapor is distilled from the solution by heat, produced from either LP gas or electricity and then carried to the finned condenser where it liquefies. The liquid then flows to an evaporator where it creates cold temperatures through evaporation.

LEVELING

Always park the vehicle on a level location when operating the refrigerator while parked. Operating the refrigerator off-level for longer than 1 hour can result in a form of 'vapor lock' that could permanently damage the refrigerator. Normal vehicle leveling to provide comfort for the occupants is generally satisfactory for refrigerator operation.

A small round bubble level is provided with your refrigerator. Place the bubble level on the bottom surface of the refrigerator and watch the position of the bubble in relation to the circle in top of the level.

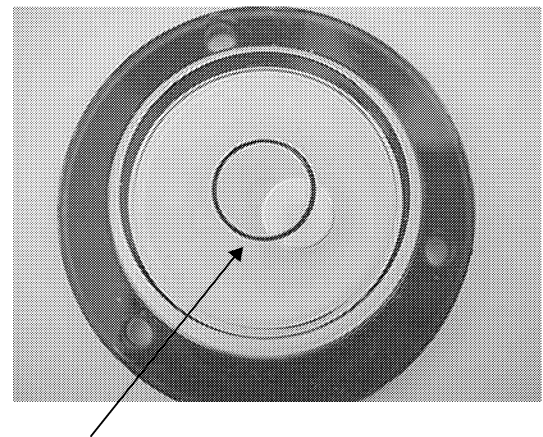

If over 1/2 of the bubble is inside the circle in any direction, the coach is level enough for continuous operation of the refrigerator while parked.

CAUTION

To prevent permanent damage to the refrigerator cooling unit, turn the refrigerator off if the vehicle will be parked on an incline of over 3° side-to-side or 6° front-to-rear (such as steep driveways or parking lots, etc.) for more than one hour.

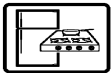

Normal vehicle leveling to provide comfort for the occupants is satisfactory for refrigerator operation. This will be well within the operation limits of 3° off-level side-to-side and 6° off-level front-to-back.

OPERATING INSTRUCTIONS
Norcold Model 900-Series Models with Electronic Auto Mode Control



Push door handle downward and pull to open refrigerator.
Lift freezer handle to open.

Start-Up Instructions - Gas Mode

The control panel is located between the freezer compartment and fresh food compartment. It contains pressure sensitive touch switches and LED display. The AC, LP GAS, Battery, and AUTO LED's (A) illuminate to indicate the refrigerator's operating mode.

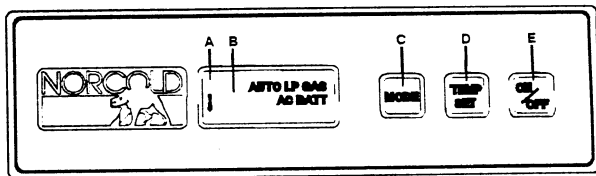

The ON/OFF button (E) turns the refrigerator On or Off. If the button is pressed, it will turn the refrigerator On and set the mode to AUTO. When the refrigerator is On, pressing this button for 2 seconds will turn the refrigerator Off.

Pressing and holding the MODE button (C) allows the user to cycle through the three mode choices; one AUTO and two manual modes (AC, LP GAS). The refrigerator will not switch to the new operating mode until the mode button is released.

The TEMP SET (thermostat) button (D) controls the refrigerator and freezer temperature during both gas and electric operation. Press and hold the TEMP SET button to select the desired temperature setting. The temperature settings are shown in the form of LED's (A). The illuminated LED indicates the temperature setting, with COLD on the left and COLDEST on the right. The temperature LED turns off after 10 seconds. Quickly press and release tempset button to display the temperature setting.

Start-Up Instructions - Auto Mode

When the AUTO mode is selected, the operating control automatically selects the power source using the following priority scheme:

- When 110 volts AC is available to the refrigerator, the AUTO LED and the AC LED will illuminate, indicating the refrigerator is operating on AC electric. After 10 seconds, the AC LED will turn off and only the AUTO LED will remain illuminated. Press and quickly release mode button to display the operating mode.
- If 110 volts AC is not available, the refrigerator will switch to the gas operation. The AUTO LED and the LP GAS LED will illuminate. After 10 seconds, the LP GAS LED will turn off and only the AUTO LED will remain illuminated. Press and quickly release mode button to display the operating mode.

During operation in the AUTO mode, when a higher priority power source becomes available, the operating controls will cease using the current power source and will switch to the higher priority power source. For example, if AC electric becomes available while the refrigerator is operating in the AUTO LP GAS mode, the refrigerator will switch to AUTO AC operation.

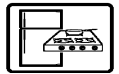

If an operating mode is not functional, its corresponding LED will flash and the refrigerator will attempt to operate in a lower power priority source. If a lower power priority source is not available, the LED will continue to flash, and the refrigerator will cease operation until the energy source is corrected. Refer to the “Diagnostic” section on page 7 of the “Norcold 9100 Series Refrigerators Operator’s Guide” in your InfoCase.

Start-Up Instructions - Manual Mode

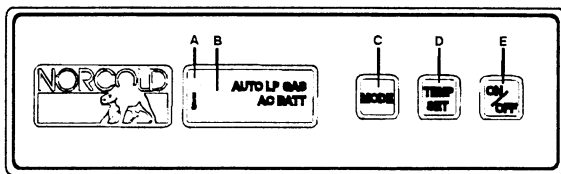

To operate the MANUAL mode, press and hold the MODE button (C) until the AUTO LED disappears and the desired operating mode is displayed. If the power source is interrupted while operating in the MANUAL mode, the AUTO LED disappears and the desired operating mode is illuminated. Unlike AUTO mode, the operating mode LED remains illuminated until an alternate mode is selected. If the energy source is interrupted while in the MANUAL mode, the corresponding LED flashes, and the refrigerator ceases operation until an alternative energy source is selected or the problem is corrected. Refer to the “Diagnostics” section on page 7 of the Norcold Operator’s Guide in your InfoCase for corrective actions.

AUTO and MANUAL Modes - Gas Operation Only

If the gas does not ignite within 30 seconds, which may occur on initial start-up, the refrigerator’s gas valve will automatically close and the operating controls will select an alternate power source (AUTO Mode) or revert to a stand-by mode in which the LP GAS LED flashes. The LED continues to flash until the refrigerator is turned OFF and then ON. If the gas does not ignite after several attempts, check the input gas supply, or consult with your dealer or a Norcold

authorized service center. A different mode of operation may be selected by pressing and holding the MODE button. The refrigerator will not switch to the new operating mode until the MODE button is released.

Backup Operating System (“BOS”)

Your refrigerator features a Backup Operating System which keeps the refrigerator cool in the event of a failure of the refrigerator’s operating controls. If a failure occurs, the TEMP SET LED flashes and refrigerator switches to the BOS mode. This mode provides refrigeration until the refrigerator is serviced. The fresh food and freezer compartment temperatures should be monitored to prevent over-freezing or thawing of refrigerator contents when operating in the BOS mode. If the refrigerator temperature is too cold, adjust the thermostat to the left in single LED increments. If the refrigerator temperature is too warm, adjust the thermostat to the right in single LED increments. Let the refrigerator operate at the new setting for one hour before rechecking the freezer and fresh food compartment temperatures. (Frequent door opening prevents the temperatures from stabilizing.) Although the refrigerator can operate in this mode, Norcold recommends that you seek service to restore manual operation as soon as practical.

Operating Tips

- The refrigerator should already be cold before placing items in it.
- Food and beverages should also be cold before placing in RV refrigerator. Never put warm or hot items in a cold refrigerator.
- Do not pack the refrigerator too full. The refrigerator needs room for cold air to circulate.
- Use smaller containers for each item. (e.g. a half gallon container of milk instead of a half-full gallon jug)
- Always put foods, especially liquids, in tightly sealed containers.

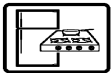

- Use crumpled paper between loose items to reduce rattling or “clinking” noises.

Further Information

For further information and operating cautions, see the Norcold refrigerator operating instructions included either inside the refrigerator or in your InfoCase.

WARNING

Most LP gas appliances used in recreational vehicles are vented to the outside of the vehicle. When parked close to a gasoline pump, it is possible that the gasoline fumes could enter this type of appliance and ignite from the burner flame, CAUSING A FIRE OR AN EXPLOSION.

FOR YOUR SAFETY, it is recommended that all LP gas appliances which are vented to the outside should be shut off when refueling.

How to Use the Refrigerator Food Storage Compartment

The food storage compartment is completely closed and unventilated, which is necessary to maintain the required low temperature for food storage. Consequently, foods having a strong odor or those that absorb odors easily should be covered. Vegetables, salads, etc. should be covered to retain their crispness. The coldest positions in the refrigerator are under the cooling fins and at the bottom of the refrigerator. The warmer areas are on the upper door shelves. This should be considered when placing different types of food in the refrigerator.

When the refrigerator is heavily loaded, it will take a longer time to lower the temperature; therefore, to get maximum efficiency the refrigerator and food items should be pre-cooled prior to loading. The shelves should not be covered with paper or plastic, and the food items should be arranged so air can circulate freely.

Frozen Food Storage Compartment

Quick frozen soft fruits and ice cream should be placed in the coldest part of the compartment,

which is on the top freezer shelf. Frozen vegetables may be stored in any part of the compartment.

This compartment is not designed for deep or quick freezing of food. Meat or fish, whether raw or prepared, can be stored in the frozen food storage compartment provided they are pre-cooled first in the refrigerator. They can be stored about three times longer in the frozen food compartment as compared to the fresh food compartment. To prevent food from drying out, keep it in covered dishes, containers, plastic bags or wrapped in aluminum foil.

Ice Making

Ice cubes can be made in the ice trays placed in the freezer compartment. The trays should be filled with water to within 1/4” (5 mm) from the top. For faster ice making, the trays should be placed in direct contact with the freezer shelves.

To release the ice cubes, seize the tray with both hands and twist the tray. Cubes not required should be replaced in the tray. Refill the tray with water and replace the tray on the freezer shelf.

Ice will be made more rapidly if the thermostat is set at its highest position.

It is a good idea to do this a few hours before the anticipated need for ice, but be sure to move the thermostat back to normal setting, usually about mid setting when the ice is formed. Food in the lower compartment may be frozen if the setting is left on “COLDEST” position.

Defrosting

Shut off the refrigerator by pressing the main power ON/OFF button to the (OFF) position.

Empty the refrigerator, leaving the drip tray under the finned evaporator, and the cabinet and freezer doors open. Defrosting time can be reduced by filling the ice trays with hot water and placing them on the freezer shelves.

When all the frost has melted, dry the interior of the refrigerator and freezer with a clean cloth. Replace all food and set the thermostat to the COLDEST temperature setting for a few hours. Then reset the thermostat to the desired setting, usually at mid setting.

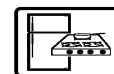

CAUTION

DO NOT use a hot air blower. Permanent damage could result from warping the metal or plastic parts. DO NOT use a knife or an ice pick, or other sharp tools to remove frost from the freezer shelves. They can create a leak in the ammonia system.

Cleaning

Cleaning the refrigerator is usually done after it is defrosted or put into storage. To clean the interior liner of the refrigerator, use lukewarm weak soda solution. Use only warm water to clean the finned evaporator, ice trays and shelves. NEVER use strong chemicals or abrasives to clean these parts as the protective surfaces will be damaged. It is important to always keep the refrigerator clean.

Shut Off - Storage Procedure

Shut off the refrigerator by pressing the main power ON/OFF button to the (OFF) position.

If the refrigerator will not be in operation for a period of weeks, it should be emptied, defrosted, cleaned and the doors left ajar. The ice trays should also be dried and kept outside the cabinet.

CAUTION

DO NOT store explosive substances in the refrigerator, such as cigarette lighter gas, petrol, ether or the like.

NOTE: The climate control will draw 12 volts DC power continuously when in the ON position. It should be turned OFF when a charging source is not available.

REFRIGERATOR COMPARTMENT

(Exterior)

The exterior refrigerator compartment allows access to the rear of the refrigerator for inspection, maintenance and service.

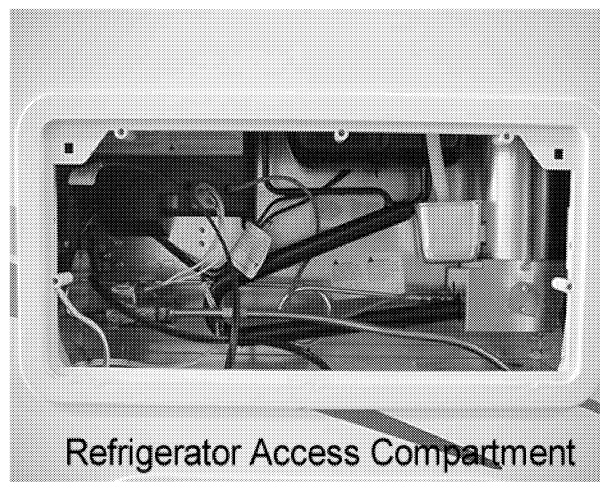

To Open:

1. Use a coin to turn the latch knobs to the vertical position as shown.
2. Remove the door from the opening.

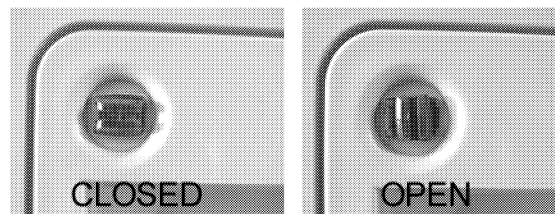

Refrigerator Access Door Latches

To Close:

1. Replace the door into the opening.
2. Push the latch knobs in while turning to the horizontal position as shown.



LP GAS COOKTOP

The cooktop in your motor home operates on LP gas and will provide the same functions that the range in your home does.

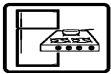

Gas Cooktop

The following warning label has been located in the cooking area to remind you to provide an adequate supply of fresh air for combustion.

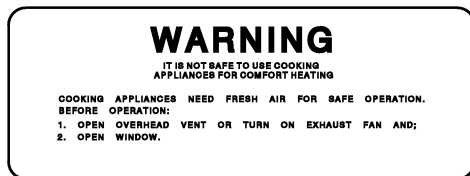

Unlike large homes, the oxygen supply inside a recreational vehicle is limited due to its size. To avoid danger of asphyxiation, provide proper ventilation when using the gas rangetop or gas oven. It is especially important not to use the gas oven and range top for comfort heating. Danger of asphyxiation is greater when these appliances are used for long periods of time.

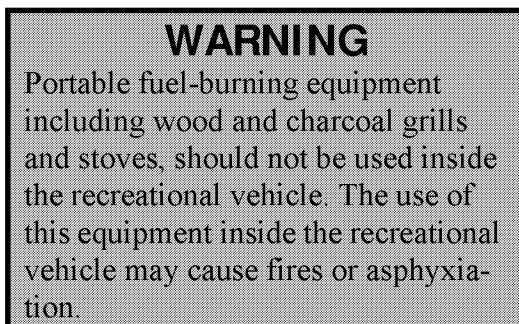

Lighting Cooktop Burners (w/Pilotless Ignition)

1. Be sure LP gas tank main supply valve is open.

2. Rotate the knob to the lighting bolt symbol to provide ignition spark.
3. When the burner lights, turn the knob back to adjust the flame height.

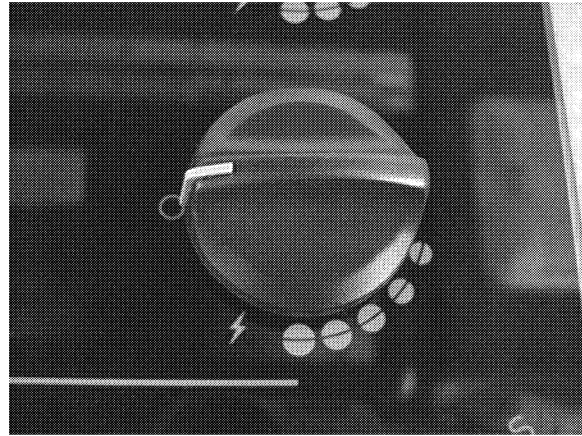

Rotate knob to lightning bolt (spark) to light burner.

Further Information

See the Cooktop *Use and Care Guide* in your Owner InfoCase for more precautions, operating and care instructions.

MICROWAVE OVEN (Optional)

For complete operating instructions, refer to the manufacturer's information provided with the oven.

RANGE HOOD

The range hood vent draws cooking odors and airborne grease particles into the activate charcoal filtration grid and recirculates the filtered air. A light on the underside of the hood provides added illumination for food preparation.

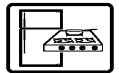

See the manufacturer's information for instructions on replacement of light bulbs and grease filter elements.



ONE PLACE MONITOR PANEL

The OnePlace Monitor Panel provides a convenient central location for checking the condition of all utility systems in your coach. At the touch of a button this panel can display the fresh water and holding tank levels, LP gas tank level, plus the engine battery and coach battery condition. You can start the auxiliary generator or turn on the water pump and water heater. Indicator lights tell you if the water pump is on or if the water heater pilot light is out. It also includes the climate control thermostat and the PowerLine Energy Management System status panel.



One Place Monitor Panel

Water and Holding Tank Levels

Press and hold the switch to show approximate level on the monitor lights.

Approximate levels of the fresh water and holding tanks are measured by sets of electronic probes in the sides of the tanks. The liquid must be at or above a probe to illuminate the indicator lights to a given level.

For example, a water level of 1-2" above the 1/3 probe would register as only 1/3 full. Consequently, a level of merely 1" below the 1/3 probe would register empty. Generally speaking, there is actually more liquid in a tank than indicated.



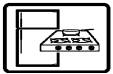

Tank Capacities

See back of “To The Owner” page inside front cover of this manual.

LP Gas Level

Press and hold the switch to show approximate LP tank level.

The LP level is registered by a sending unit on the tank. The gauge mounted on the side of the tank will give a more accurate indication of actual tank level if needed.

Water Pump Switch

When use of the self-contained water system is desired, turn the “Water Pump” switch on. The “Pump On” light will illuminate when the pump switch is on and the system is operable. Water will be available as soon as a faucet is opened. Refer to “Fresh Water System” for additional information on the water pump and initial start-up.

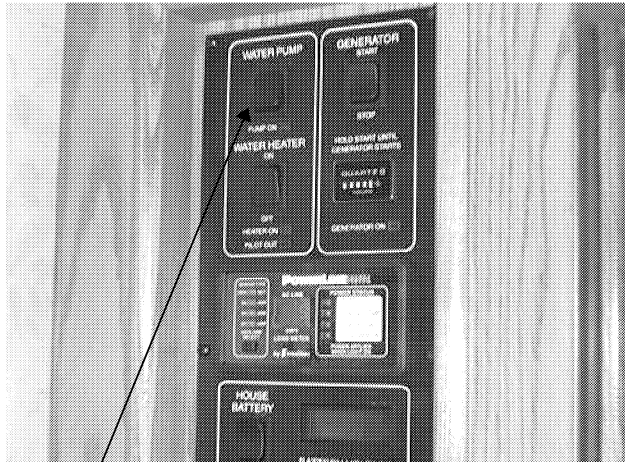

Water Pump Switch

Battery Voltage Meter

Push the button to check the level of charge in the 12-volt house battery.

The LCD display will show the current battery voltage to the nearest tenth of a volt.

- A 12-volt battery typically registers anywhere from 12.5V to 13V when adequately charged.

- Voltage below 12.5V indicates a discharged condition; 12V or less is dead.
- Voltage above 13V typically indicates that the battery is being charged by the inverter charger system.



Battery Voltage Check
One Place Panel

To get an accurate reading;

1. Both the chassis engine and the auxiliary generator engine must be shut off.
2. An interior light should be turned on to provide a small load which draws off the battery surface charge.

The “Pilot Out” light will glow for about 10-15 seconds after the water heater switch is turned on, then it will go off. The “Heater On” light will remain lit.

If the “Pilot Out” light comes on during normal operation, it means that the burner has gone into “lockout” mode. Turn the switch off for about 5 minutes, then turn back on.



**GAS/ELECTRIC
WATER HEATER
(with Motor Aid water heating system)**

Capacity: 10 gal.

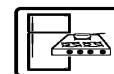

The water heater has a dual power feature. It can operate from LP gas or 110-volt house current; or it can use both at the same time for quicker recovery at times when you are using a lot of hot water.

Read the Atwood Gas Water Heater Installation and Operation Manual for complete Safety Warnings, Operating Instructions and Maintenance Information before operating the water heater.

Be sure the water heater is filled with water before starting either electric or LP operation. To fill the water heater, turn the Water Pump switch on and open a hot water faucet anywhere in the coach. When water begins to flow steadily from the faucet, the water heater is full.

For Electric Operation: Turn on the Water Heater electric element switch. The shoreline must be connected for electric operation.



Electric Water Heater Switch

- * 36 ft. models: above OnePlace panel
- * 39 ft. models: beneath hutch

For LP Gas Operation: Press the Water Heater switch on the Monitor Panel. The “Pilot Out” light will glow for about 10-15 seconds, then it will go out. If the “Pilot Out” light comes on during LP operation, it means that the burner has gone into “lockout” mode and must be restarted. If this happens, turn the Water Heater switch off for about 5 minutes, then turn it back on. See the Atwood user’s guide in your Owners InfoCase for further information.

For Quick Recovery Operation (Dual): Turn On both Water Heater switches; the gas one on the monitor panel and the electric one. This will help reheat the water heater tank more quickly than a single source would alone. Use this mode when you are using a larger than normal volume of hot water, for example, when someone is taking a shower and the dishwasher or clothes washer is also being used.

Gas Safety Information

- A. This appliance does not have a pilot light. It is equipped with an ignition device that automatically lights the burner. Do Not try to light the burner by hand.
- B. Before lighting, smell around the appliance area for gas. Be sure to smell near floor because LP gas is heavier than air and will settle on the floor.

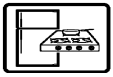

WHAT TO DO IF YOU SMELL GAS

- Do not try to light any appliance.
- Do not touch any electrical switch.
- Get out of the coach immediately and turn off the LP gas tank at the main tank valve. (See photo on page 5-2.)
- Use a neighbor's phone to call your Winnebago Industries dealer or a local gas supplier for instructions. Do not use a phone in your coach. Follow the dealer's or gas supplier's instructions.
- If you cannot reach a Winnebago Industries dealer or a local gas supplier, call the fire department.
- Have the source of the leak corrected before using the LP gas system again.

Operating Instructions

1. STOP! Read the safety information provided in the Atwood Water Heater Operation Manual in your Owners InfoCase.
2. Turn off water heater power switches.
3. Turn LP gas supply off.
4. Wait five minutes for any gas to clear the area. If you smell gas, then stop and follow item B of the Safety Information above. If you don't smell gas, go to the next step.
5. Turn on LP gas main tank valve.
6. Turn on the water heater switch on the monitor panel. You may hear a clicking noise as the ignition element begins working. If the burner does not light on first try, the system will stop trying to light burner and go to lockout mode.
7. If lockout happens before main burner lights, turn switch OFF, wait five seconds and turn switch back on. This will restart the ignition cycle. The first start-up of the water heater after it has not been used for a long time may require several ignition cycles before all the air is purged from the gas lines and gas begins to flow.
If the burner will not come on, check the following items before calling for service.
 1. Is the switch turned on?
 2. Does the LP tank have gas in it or is main tank valve turned on?

3. Is the ECO Reset button tripped? (See *Atwood Water Heater Operation Manual* in your Owners InfoCase.)

To Turn Water Heater Off

1. Turn switch on monitor panel to Off position.
2. Turn electric water heater switch off.
3. Turn off LP gas supply (if not to be used for extended period).
4. Drain water heater tank if the coach is to be stored or water heater will be Off during freezing temperatures. (See Draining and Storage Instructions in *Atwood Water Heater Operation Manual* in your Owners InfoCase.)

Pressure-Temperature Relief Valve

On occasion, water may be seen seeping from the water heater pressure temperature relief valve. This is no cause for repair or replacement of the valve.

P-T Relief Valve

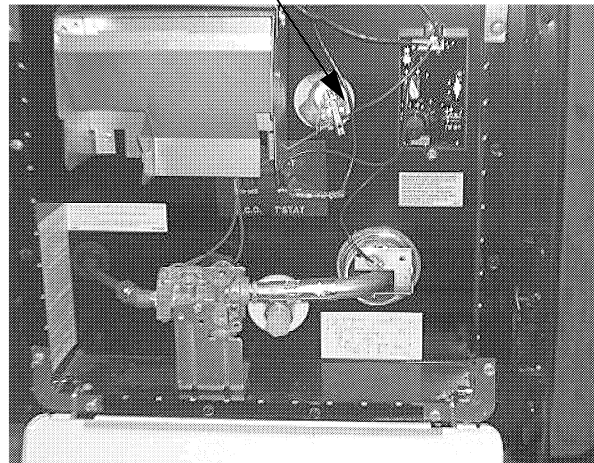

Normally there is an air gap at the top of the water heater tank which acts as a pressure buffer. In time, however, heated water may expand and fill this air gap, causing a slight increase in water pressure. This may cause the P-T valve to "weep" until the air gap is manually replaced.

OPERATE THIS VALVE ONLY WHEN THE WATER HEATER AND COOLING SYSTEM ARE COLD!

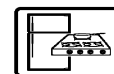

To Replace the Air Gap:

1. Turn off the water heater switch and incoming water supply (city water and/or demand pump).
2. Open a faucet in the motor home to relieve water pressure.
3. Pull the handle of the P-T valve straight out and allow water to flow until it stops.

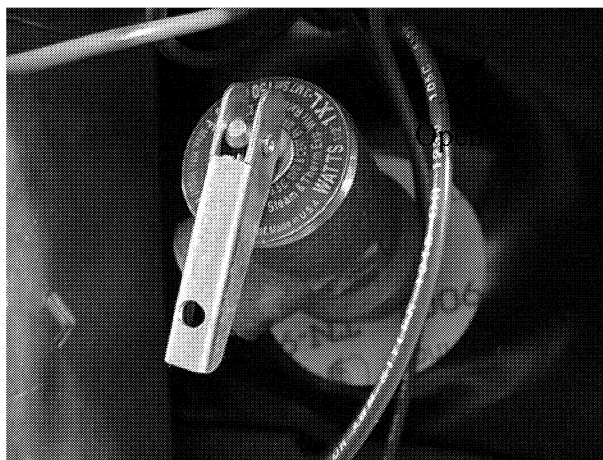

Lift handle straight out to open P-T valve.

4. Let the handle of the P-T valve snap shut.
5. Close the faucet and turn on the water supply before switching the water heater on.

Manually operate the pressure temperature relief valve at least once a year.

WATER HEATER BY-PASS VALVE

Your coach may be equipped with a water heater by-pass valve for easier winterization of water lines using RV antifreeze.

See “Water System Drain Valve Locations” at the end of Section 7 - Plumbing for location of the water heater bypass valve for your model coach.

NOTE: Your coach is not equipped with this valve if you have the optional automatic winterization system

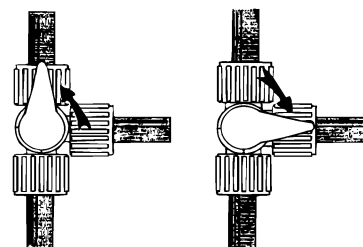

Normal
Flow

By-Pass
Mode

CAUTION

Leave by-pass valve handle in NORMAL FLOW position if draining water and blowing out water lines. Place in BYPASS position ONLY when using antifreeze solution in water lines.

MOTOR AID (Auxiliary Water Heating System)

The motor aid uses heat from the chassis engine cooling system to heat water in the water heater while driving. Hoses are routed from the engine to a heat exchanger surrounding the water heater tank.

Under normal conditions, the entire contents of the water heater can be heated to about 140°F in about two hours or 100 miles of driving. This means you can have hot water at the faucets immediately upon arriving at a site, or even while driving if needed.

The motor aid also increases the capacity of the engine cooling system, allowing the engine to run cooler under many conditions.

CAUTION

Any leak in the heat exchanger or its supply or return lines could cause loss of coolant and subsequent engine failure. We recommend that you periodically inspect these connecting lines and the heater to insure that no leaks have developed.

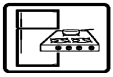

Motor Aid Water Heater and Auxiliary Coach Heater Maintenance

Have your authorized dealer check all hose clamp connections on the rear automotive heater and the motor aid water heater at least every six months and tighten them if necessary.

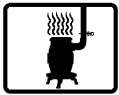

**LP GAS FURNACE
(SUBURBAN)**

Start Up:

o Start Up:

1. **Open the LP gas tank valve** by turning fully counterclockwise
2. Place the **FAN MODE** switch in ‘Auto’ position. (Place the FAN SPEED switch in whichever position you wish. For colder temperatures we recommend ‘Lo’.

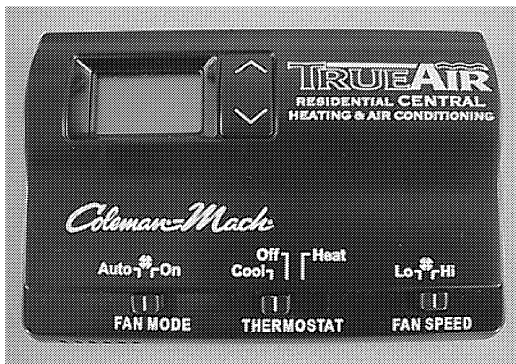

3. Press the **Temperature Selector** button **Up** or **Down** until the desired temperature appears in the Display.
4. Move THERMOSTAT switch to ‘Heat’ position (or to ‘Gas Heat’ if you have the optional Heat Pump system.) The Furnace fan should start to blow immediately.
5. After about 30 seconds, the furnace burner will light.
6. The furnace will now cycle off and on automatically as the thermostat demands just like a household furnace.

NOTE: If heat does not come out of the heat ducts after a minute or so the burner is not lit. Turn thermostat off for 3-5 minutes, check to be sure tank valve is open

and tank is not out of fuel, then try steps 2-4 again. If it still will not light after three attempts, go to Shut Down steps and contact your dealer or a local RV service center.

To Shut Down:

1. Slide thermostat/system switch OFF.
2. Close LP tank valve.

For Further Information

Please see the Suburban furnace operating instructions provided in your Owners InfoCase for further information, including operating precautions, and periodic maintenance.

ELECTRONIC THERMOSTAT

(Central Heat/Air Conditioning System Only)

The thermostat, located in the galley area, controls heating, air conditioning and cooling fan features.

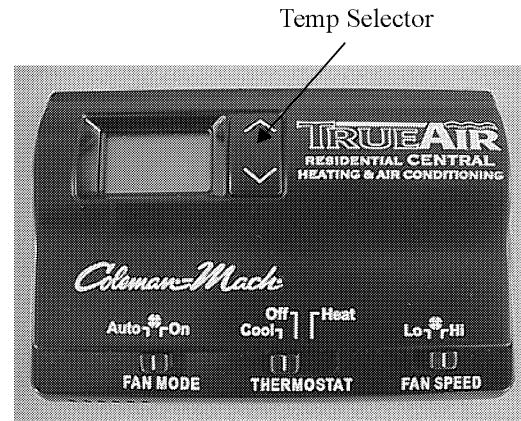

NOTE: The thermostat does not automatically switch between heating and cooling. You must place the switch in the desired position.

Heating:

- Slide the thermostat switch to “Heat” position.

NOTE: Follow proper furnace lighting procedures described previously in this section.

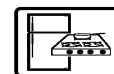

NOTE: If your coach is equipped with the optional electric Heat Pump, be sure the Thermostat switch is in Gas Heat position. See Heat Pump for details.

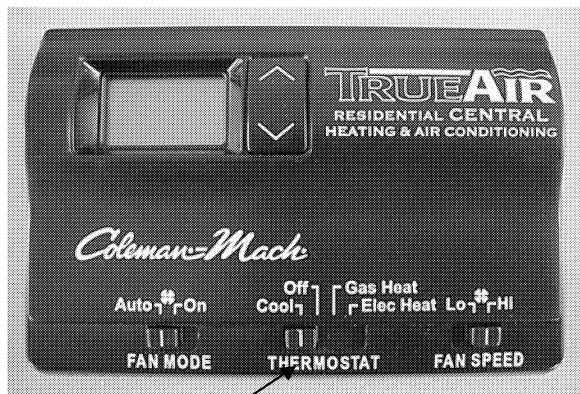

Heat Source Switch
ELECTRIC = Heat Pump
GAS = Furnace

- Adjust the temperature setpoint to personal preference if needed. See “Set Temperature” below.

Digital Thermostat Display

The digital display normally shows current room temperature, with the word “ROOM” in small letters at the left side of the display. When you press the temperature selector button up or down, the display will show the word “SET” and the new temperature setpoint until you release the button.

Set Temperature

To set the temperature to a new temperature, simply press the Temperature Selector button up or down until the temperature you want appears in the display. The word “SET” will also appear at the left side of the display while you are changing the temperature setpoint. A few seconds after you release the temperature selector button, the display will return to showing the current room temperature.

Cooling (A/C):

- Slide the thermostat switch to Cool position.
- Slide the Fan Mode and Fan Speed Switches to the desired positions.

On/Low: A/C compressor cycles on and off with the thermostat while fan runs continuously at low speed.

On/High: A/C compressor cycles on and off with the thermostat while fan runs continuously at high speed.

Auto/Low: Fan runs at low speed and cycles on and off with the A/C compressor as controlled by the thermostat.

Auto/High: Fan runs at high speed and cycles on and off with the A/C compressor as controlled by the thermostat.

- Adjust the temperature setpoint to personal preference if needed. See “Changing Temperature Setpoints”.

To Run Fan Only (No Heat or Air)

- Set Thermostat switch to OFF.
- Slide Fan Mode switch to On.
- Place Fan Speed switch to Lo or Hi as desired
- The fan will run continuously at the selected speed and is not controlled by thermostat setting. The display will show current room temperature.

HEAT PUMP - Optional

Your coach may be optionally equipped with an air source heat pump built into the central air conditioning system. Because the heat pump operates on electricity, it provides economical heat inside your coach and helps reduce the use of LP gas for heating in cooler weather.

A heat pump can be thought of as an air conditioner running in reverse. An air conditioner absorbs heat from the air inside of the coach and moves it to the outside. The heat pump does exactly the opposite. Even cold air contains some heat, so a heat pump will extract heat from the outside air on a cold day and carry it to the inside of the coach to maintain a comfortable temperature.

The efficiency of a heat pump decreases as the outdoor air temperature drops, so supplementary heat is often needed when the outside temperature nears freezing. This system is set to automatically start the LP gas furnace to assist the heat pump if room temperature cools to 5 degrees F or more below the thermostat setpoint. You may wish to manually switch to furnace heat to main-

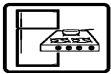

tain a higher temperature when outside temperatures begin to reduce the efficiency of the heat pump. The heat pump will not operate when the outside temperature falls below 36 degrees F.

To Operate the Heat Pump:

- Slide the thermostat switch to electric heat mode.
- If the inside temperature is 5 degrees or more below the thermostat set point, both the heat pump and the furnace will run initially to bring the interior temperature up to the set point as quickly as possible. (If the inside temperature is 4 degrees or less below the set point, then only the heat pump will run initially.)
- When the thermostat calls for heat again, only the heat pump will run. The heat pump will remain the sole heat source unless it cannot maintain the inside temperature. If the inside temperature falls five degrees below the set point, the furnace will assist the heat pump until the set point is reached.

If the furnace must assist the heat pump three times in a row, the thermostat will shut down the heat pump for two hours and the furnace will take over as the heat source. After two hours the heat pump will become active again and try to be the primary heat source.

The furnace acts as a standby heat source if the outside temperature drops below a point that the heat pump can no longer extract heat from the outside air to maintain the desired inside temperature.

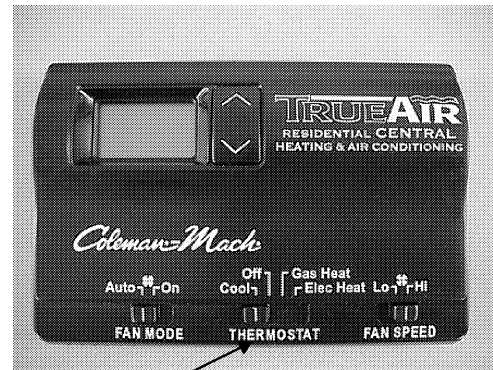

Thermostat Switch
Gas Heat = Furnace Only
Elec Heat = Heat Pump

Is the airflow blocked?

Closed or blocked vents and a dirty air filter can hinder the efficiency of a heat pump.

- Be sure ceiling vents are open to distribute heat pump output air. Also make sure furniture, clothing items, packages or other obstructions do not block the air return air grilles beneath the rear bed.
- The air conditioner filter should be checked monthly for dirt build-up and replaced as needed. The air filter is a disposable woven fiberglass type, which cannot be cleaned and should be replaced when coated with dust. See Air Conditioner Filter for location and instructions.



CENTRAL AIR CONDITIONING SYSTEM

NOTE: See "Electronic Thermostat" for instructions on turning the air conditioner on and changing the thermostat settings.

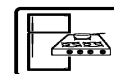

The central air conditioner is mounted in an exterior compartment on the left (driver) side of the coach. (See page 0-4.) The compartment door opens for easy maintenance and periodic service. (See “Condenser Coils”) The cooled air is forced through ducts in the ceiling of the coach. Inside air returns to the air conditioner through a filter system beneath the rear bed. (See “Air Conditioner Filters”.)

Air Conditioner Filter

The disposable furnace type filter is located beneath a panel under the rear bed mattress board. The filter must be inspected and replaced periodically so the air conditioner will operate efficiently.

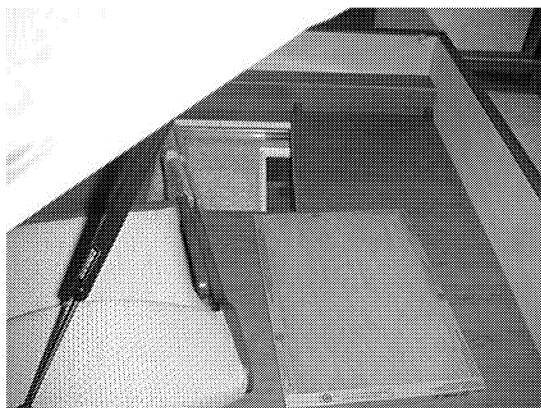

To Replace the A/C Filter:

- Lift the foot of the rear bed mattress board, which is hinged near the head of the mattress. It is supported by gas props while open.
- Lift the filter out of the bracket assembly beneath the access panel.
- Place the new filter into the bracket, being careful to observe airflow markings on the edge of the filter.

Secondary Filter - 39 ft. Models only

The secondary AC filter is located in the floor beneath the wardrobe bottom drawer. Remove the drawer to access the filter.



A/C Filter Size: 14” x 20” x 1”

NOTE: Do not block the air return grille at the side of the bed in any way, such as by setting packages or newspapers, etc., in front of it. There must be free air flow for the air conditioner to operate efficiently.

Condenser Coils

The condenser is located in a compartment on the right side of the coach. The condenser is the large, black, rectangular area that looks like a car radiator.

Periodically sweep debris carefully from the fins of the condenser. Rinse dust off with clean water. The condenser coils must be clean and free of dust, debris and insect particles, etc., for the air conditioner to cool efficiently.

Further Information

See the air conditioner manufacturer’s operating instructions supplied in your Owners Info-Case. They contain detailed operating instructions, special precautions and basic troubleshooting.



TV ANTENNA - Optional

The TV antenna on your motor home can be easily raised, rotated a full 360° and lowered from inside the vehicle by simply turning a crank or rotating knob. A built-in signal amplifier designed to strengthen signals, is controlled by a

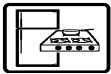

power switch built into the TV jack assembly.

The signal amplifier is housed inside the antenna with the circuit board connected directly to the antenna elements. Power to operate the amplifier (12-volt DC) is supplied through the download cable which also carries the TV signals to the TV set. The power supply separates the 12-volt DC from the TV signals and provides a place for attaching the TV set and the 12-volt power source.

Raising Antenna - Turn elevating crank clockwise in "UP" direction about 13 turns or until some resistance to turning is noted. Antenna is now in operating position. Turn amplifier power switch "ON" to receive TV signal.



WARNING

Never allow the antenna to touch electrical power lines or any other electrical wires.

Rotating Antenna - Make sure antenna is in the "UP" position. Pull down on rotating knob until it disengages ceiling plate and rotate for best picture and sound on TV set.



Lowering Antenna to Travel Position - Rotate antenna until pointer on rotating knob aligns with pointer on ceiling plate.

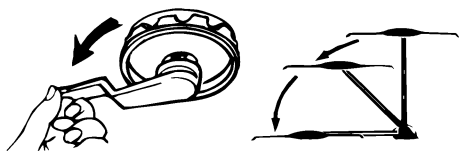

CAUTION

Never leave the antenna partially raised or partially lowered. This can damage the crank mechanism gears. Always raise the antenna straight up or lower it completely into the travel position.

Turn elevating crank (counterclockwise) in "DOWN" direction until resistance is noted. Antenna is now locked in travel position. Turn amplifier power switch "OFF".

Count the number of turns needed to crank the antenna down to the roof of the unit (normally about 13). Mark the final position of the crank handle on the ceiling or the directional knob for reference. Also mark the number of turns needed. Use the mark and number as a reference whenever you lower the antenna.

CAUTION

Always align directional handle to "DOWN" position before lowering.

ANTENNA CHECK LIGHT

The antenna check light on the steering column will come on for 20 seconds when the ignition switch is turned On to remind you to be sure the TV antenna is lowered completely into the roof cradle for travel storage.

SIGNAL AMPLIFIER

The amplifier power switch is located on a switch plate in the video center cabinet above the driver and passenger seats or entertainment center cabinet.

To operate amplifier, turn on power switch.

A red indicator light will glow while the signal amplifier is in use.

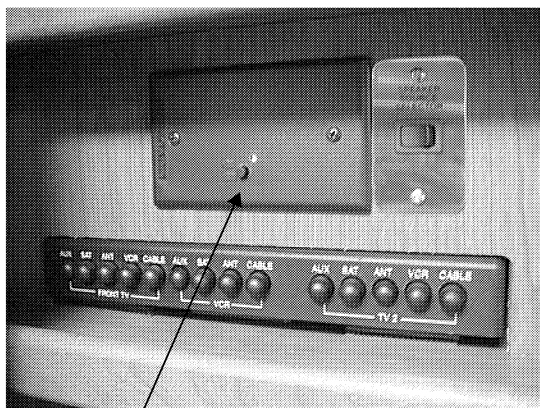
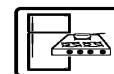

Antenna Amplifier
Switch & Indicator

Other TV jack plates are mounted in various locations throughout the coach. Some of these wall plates are not readily visible and may be in one of the following locations.

- In the entertainment center on the outside of the coach.
- In the bedroom area.

Checking Signal Performance

The TV signals available to an RV are entirely dependent on its location in relation to the transmitter. Signals may vary from strong to no usable signal at all. We recommend that the TV system be checked out in an area known to have good TV reception.

To check the antenna amplifier, raise the antenna, select a TV channel and rotate the antenna for best picture. Then turn off the amplifier power switch. If the antenna amplifier is working properly, the TV picture will now be degraded (snowy). When you turn the switch back on, the picture should again be sharp.

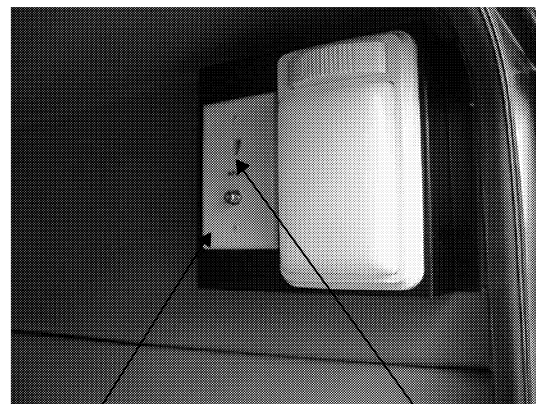

Cable TV
Input

Phone Input

NOTE: For coaches without the video control center option, be sure the TV antenna amplifier switch is turned OFF while connected to cable.



VIDEO SELECTION SYSTEM

The video selection system allows you to switch the antenna, cable TV or VCR signal to any TV set location in the coach.

This means one person can watch a ball game coming in on the roof antenna on the bedroom TV while another person watches a cable TV program or a video tape on the VCR on the front TV. Also, two people can watch different programs on the two TV's while taping a third program on the VCR.



PHONE AND CABLE TV-HOOK-UPS

Some models are equipped with external connections for telephone and cable television. The connectors are located in the shoreline cord/sewage dump compartment.

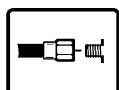

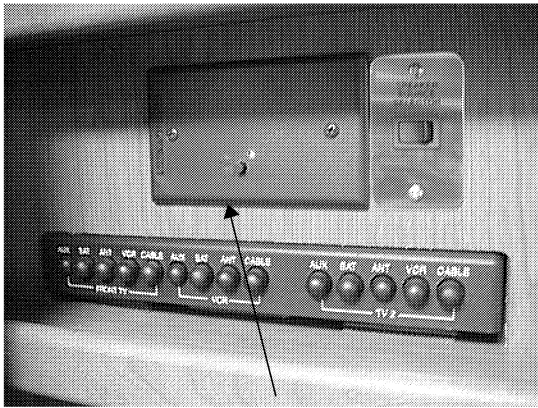
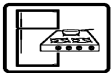

Video Selection System in Entertainment Center Cabinet

Components:

Each component has a set of buttons that lets you select which source you want to get the picture signal from, whether cable TV, roof antenna, digital satellite dish, VCR or whatever equipment you have connected to the AUX input. You will notice the VCR button group has no VCR button. That's because it wouldn't work for the VCR to get a picture signal from itself.

There are three component groups:

- Front TV
- VCR (in Video Center)
- TV2 (in Bedroom or Rear of Coach)

Selections (Signal Input):

Each button in a component group lets you select the source you want to draw the picture signal from, such as cable TV, VCR, the roof antenna, or satellite dish antenna. Press the corresponding button to connect to the desired signal source.

- AUX = Press to connect to a video component which you may have installed later, such as a Digital VideoDisc (DVD) player.
- SAT = Press to connect to the Digital Satellite System (dish antenna)
- ANT = Connects to the roof antenna.
- VCR = Connects selected TV to the VCR.
- CABLE = Connects to a local cable TV system hookup if you have connected one to your coach.

Digital Satellite System Wiring - Standard

The roof of your coach is pre-wired with coaxial cable and elevation sensor wiring for later installation of a Digital Satellite System (DSS) if not originally factory equipped.

Hookup jacks are located in the left or right front overhead compartment, depending on model.

See your authorized Winnebago Industries dealer for proper installation of this system and proper sealing of roof mounted components.



SATELLITE TELEVISION SYSTEM - Optional

The Satellite Television System allows you to receive TV programs directly from satellite to your coach. The programs are transmitted in digital format so the quality is equal to laser disc or CD.

See your **Winegard RV Digital Satellite Antenna System Owner's Manual** for instructions about aiming the satellite antenna dish. The coach must be level before attempting to aim the antenna dish.

See your **Satellite Receiver User's Manual** for instructions about setting up the receiver and remote unit.

We recommend that you **read** both of these manuals **thoroughly** to understand the system completely before attempting any setups or adjustments.

Digital Satellite Operation through the Video Control Center:

Press the AUX switch to connect the TV to the DSS system. The satellite system is hooked through the AUX input of the video control center.

EXTERIOR ENTERTAINMENT CENTER

The exterior entertainment center contains a stereo radio/cassette or CD player and convenient TV hook-ups for your outside listening or viewing pleasure.

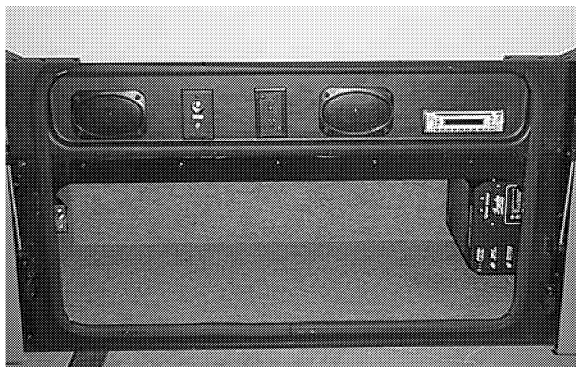
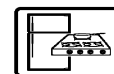

Exterior Entertainment Center
in Right Side Cargo Compartment

BEDROOM RADIO - Optional

The bedroom maybe equipped with a built-in stereo radio system in the rear nightstand cabinet. This radio features AM/FM stereo radio with electronic seek/scan tuning player.

See the Audiovox operator guide in your InfoCase for full operating instructions by the manufacturer.



SLEEPING FACILITIES

WARNING

Do not use sleeping facilities while vehicle is moving.

COUCH BED CONVERSION

To Convert Couch to Bed:

Pull the front edge of the couch seat upward and outward from the wall while gently pushing downward on the backrest until the cushions lie flat. The bed is now ready for use.

To Revert to Couch:

Push the front edge of the seat toward the wall while lifting upward on the backrest until the couch is fully seated against the wall.

DINETTE/BED CONVERSION

To Convert Dinette to Bed:

1. Release the catch on the table leg brace and fold the leg up against the bottom of the table.

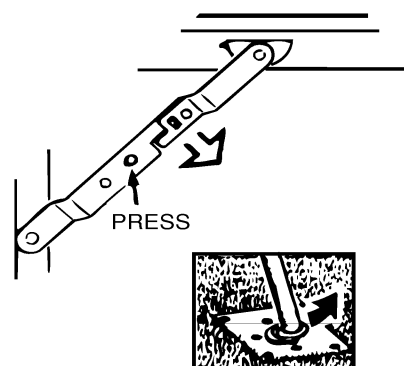

2. Remove the table from the wall support bracket by lifting the end of the table. Then lower the table to rest on the cleats attached to each dinette bench.
3. Arrange dinette cushions to cover bed area.

To Revert to Dinette:

1. Replace the table onto the wall support and lower the table leg.
2. Make sure that the table leg is secured into the floor support bracket and the leg brace is locked.

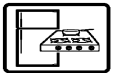

**Rest Easy™ Multi-Position Lounge -
Optional (If equipped)**

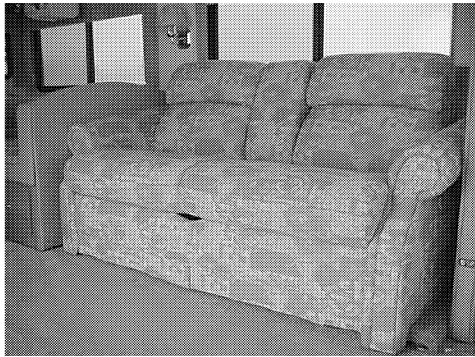

To Recline: Press the switch on the front of the armrest. Press ‘down’ to recline; ‘up’ to return upright.

CAUTION

Do not recline the lounge completely flat unless the footrest section is extended.

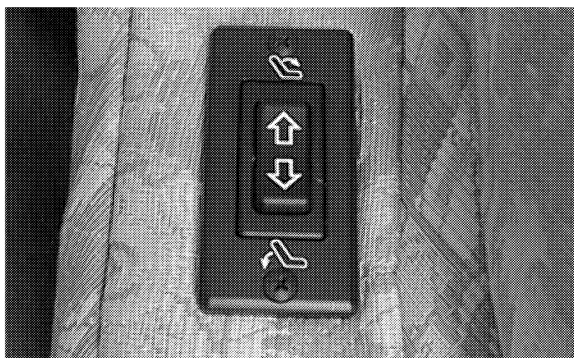

To Extend Pull-Out Footrest Section:
Squeeze latch behind opening at top of lounge face panel and pull footrest trundle section out until it locks in the fully extended position.

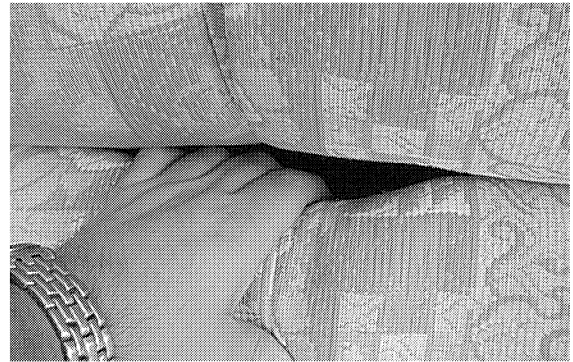

Lift footrest up and away from lounge until it is raised into position.



The gap between the footrest and seat provides ample room to enter and exit the lounge. If desired, however, the footrest can be unlatched and pushed against the lounge seat. The footrest ‘drawer’ will latch when pulled out completely and must be unlatched to push back in when stowing the footrest.



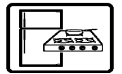

Tip for “power users”: If you have the footrest section unlatched and positioned against the seat cushion, it will move out with the lounge when you press the recline switch. When you return to upright position, you can hook your heels over the front edge of the footrest section and pull it back with you. Then, when you want to get up, simply push the footrest section forward with your feet to provide a gap for you to exit.

To Convert to Bed: Extend footrest section and push together with lounge seat cushion, then press recline button until entire lounge lies flat. Reverse steps to revert to lounge.



CAUTION

To not recline the lounge completely flat unless the footrest trundle section is extended. Do not occupy the lounge when elevating the seatback from the flat bed position to upright lounge position. If house battery voltage is low, the mechanism may require assistance by lifting the seatback while returning upright from flat bed position.

WARNING

To avoid injury to young children, do not allow them to operate the sofa, or to play within the sofa or near the operating mechanism.

RECLINER LOUNGE CHAIR

This chair is not equipped with a seat belt and is not intended for seating while the coach is in motion.

Hoop Chair Mount

The hoop base of the recliner is fastened to the floor of the coach with a clamp as shown.

While the coach is parked, the chair may be unclamped and repositioned in the living area as desired.

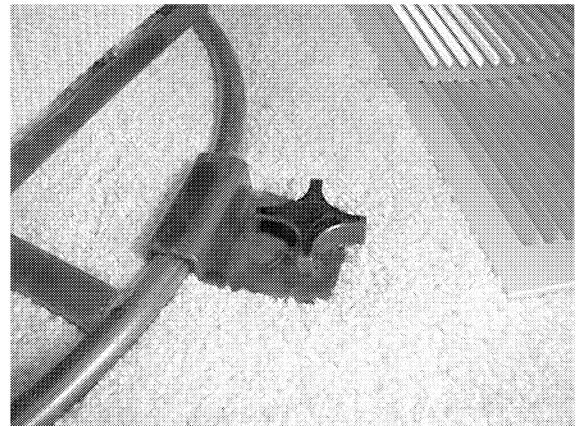

To move the chair, unscrew the knob until the clamp plate can be swiveled over the top of the hoop base.

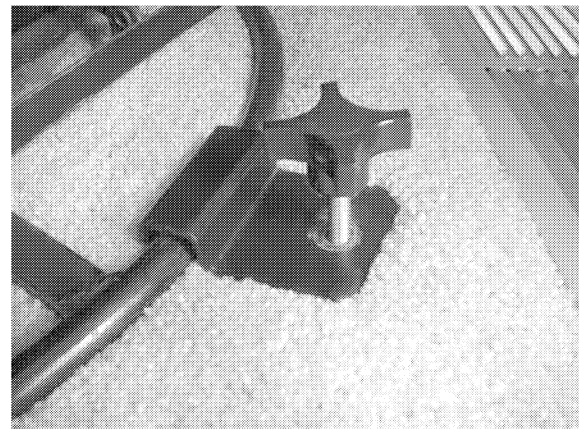

The clamp can be removed altogether as shown if the coach will be parked for a long period of time.

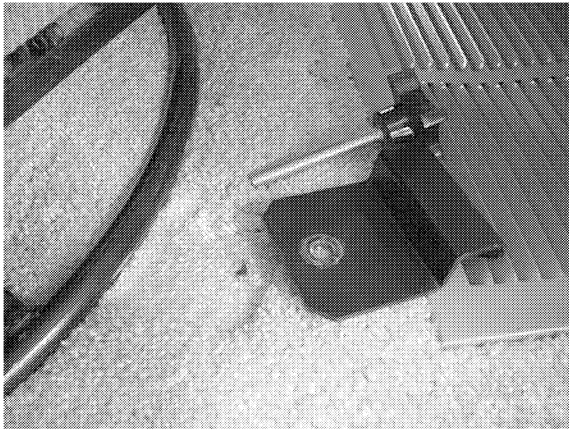
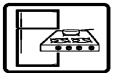

The chair will move easier if pulled by the armrest or footrest as shown rather than by pushing.

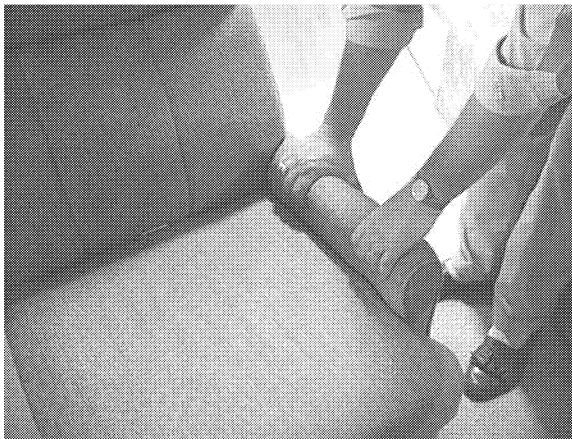

WARNING

The chair must be clamped back into place before driving the vehicle.

DISHWASHER (Optional)

For complete operating instructions, see the manufacturer's information provided in your Owners InfoCase.



WASHER-DRYER (Optional)

For complete operating instructions, see the manufacturer's information provided in your Owners InfoCase.



The washing machine water supply faucets are located inside the cabinet door above the machine. Always turn supply faucets off when not using washing machine to avoid possible water leaks if a hose or hose gasket should fail.

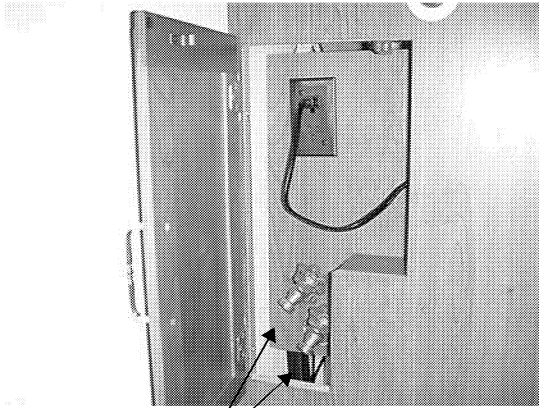
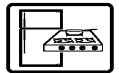

Water Supply
Faucets



FRESH WATER TOILET

The fresh water toilet in your motor home is very similar to the household type, except that it is designed to use only a small amount of water per flush. It uses a high velocity jet of water, producing a swirl effect, to efficiently cleanse the bowl. And since each flush uses fresh water, no special chemicals are required other than a deodorizing agent, if necessary.

1. To add water to the toilet before using, lift the flush lever until the desired water level is reached. Generally, more water is required only when flushing solids.

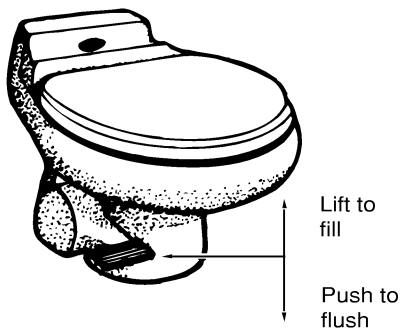

2. To flush the toilet, push the lever all the way down until sewage leaves the toilet and bowl is rinsed clean.
3. Release the flush lever. A small amount of water should remain in the bowl.

Please refer to the manufacturer's information supplied with the toilet for further operating and maintenance instructions.

Important "Don'ts"

- Don't use facial tissue or regular toilet tissue in the RV toilet. These will not disintegrate sufficiently and will often cling to the sides of the holding tank. Toilet tissue made specifically for use in RV toilets and holding tanks is available at most RV supply centers.
- Don't dispose of sanitary napkins or other non-dissolving items in the toilet.
- Don't put automotive antifreeze or caustic chemicals, such as laundry bleach or heavy detergents into the toilet or holding tank. These products may damage plastic or rubber parts in the system.

Cleaning The Toilet

The toilet should be cleaned regularly for maximum sanitation and operating efficiency. If an odor is apparent from the toilet:

1. Clean the toilet bowl with a mild bathroom cleaner. Do not allow cleaners to set in the bowl for long periods of time to avoid damaging the seals. Do not use caustic or abrasive cleaners because it may damage the plastic surfaces.
2. Dump and rinse holding tank.
3. Add odor control chemical in amount specified after cleaning and every few days during use.
4. Remove the water line from the base of the toilet and clean the screen.
5. If the flush valve becomes stiff after extended use, it may be lubricated with a silicone spray. Turn the water pump off and operate flush pedal to drain water from the toilet bowl. Spray silicone lubricant onto flush valve inside bowl and operate flush pedal a few times to ensure free operation.

See instructions in Section 10 to prepare the toilet for storage in freezing conditions.

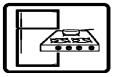

BATH VENT

The power bath vent helps to exhaust excess moisture and provide ventilation to the bathroom. Switches for the vent skylight dome (raise/lower) and vent fan (on/off) are located on the bathroom wall.

CRANK-OUT SIDE WINDOWS

Turn the crank-out knob clockwise to open window; counterclockwise to close. Do not use excessive force on the knob to open or lock into closed position. This could cause permanent damage to the crank mechanism.

When closing the window, crank the window in snugly, then back off 1/4 turn to help avoid glass warping which can result in wind noise.

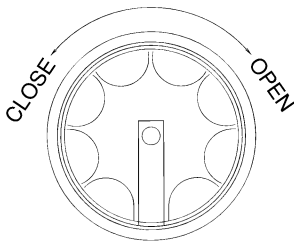

If the window will not open after three or more full turns of the knob, the glass may be stuck to the sealing gasket. Go to the outside of the coach and gently free the glass with your fingers. A periodic light dusting of talcum powder on the gasket should prevent this from recurring.

SLIDER WINDOWS

Lift the latch handle straight out from the window. Grasp the sliding window edge frame and slide the window to the side. Be sure the latch is raised before trying to slide the window closed.

Vertical slider windows have spring-loaded catches on both sides of the window that pop out to hold the window in its fully raised position. Press the catches outward toward the frames while lowering the window.

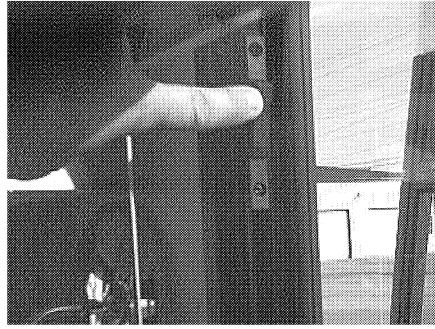

Vertical Window Catches

DAY/NIGHT PLEATED WINDOW SHADES

The pleated window shades are dual function shades that can be used for daytime or nighttime privacy.

Sun Filter: The first, lower section is a translucent white shade that can be lowered for privacy without darkening the inside the coach. It can also filter out harsh direct sunlight to help keep the inside of the coach cool in summer or to disperse light for houseplants.

Darkening Shade: The second, upper section is an opaque, darkening shade for nighttime privacy and daytime room darkening purposes. Pull both the first and second sections down together or separately.

Tension Adjustment:

The tension of the pleated shades can be adjusted if they become loose and will not stay up when raised, or they are too tight and are difficult to raise and lower.

To tighten the tension, simply wrap the lower end of the guide cords (on each side of the shade) a few turns around the spools at the lower corners of the shades.

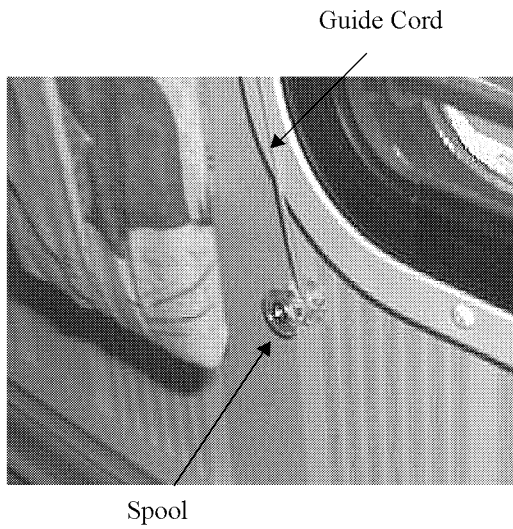
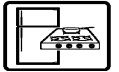

To loosen the tension, unwrap the guide cords from the spools one turn at a time until desired tension is achieved.



EXTERIOR

CAUTION

Sealants must be inspected every 6 months and resealed if necessary.

ROOF

The roof is made of Thermo-Panel materials like the walls and floor. It will support the weight of an average adult should it become necessary to repair the roof or roof mounted components. It is not recommended, however, that very large or heavy objects be carried on the roof while the vehicle is in motion. (See page 4-1 for roof loading specifications.) Always have damage to the roof area repaired immediately. Damaged or detached sealant around the vents, air conditioner, body-to-roof seams, etc., should also receive immediate attention. Delaying these repairs may allow water leakage and result in damage to interior ceiling and body panels, upholstery, etc.

UNDERBODY

Buildup of mud and dirt under the body can cause damaging rust on steel parts and can add needless weight to the vehicle. This, in effect, reduces the amount of cargo you can carry and remain with GVWR and GAWR limits.

Corrosive materials, such as those used for ice and snow removal and dust control, also accumulate on the underside of a vehicle. These materials should be removed by flushing the underbody regularly with water, especially areas where mud and other foreign materials collect.

EXTERIOR

The exterior surface of your motor home has an automotive finish. Frequent washing and thorough cleaning is recommended to prevent damage to the vehicle finish after exposure to damaging salts, calcium chloride, road tar, tree sap, insects and other foreign material. Never wash the vehicle in direct sunlight, while the vehicle surface is hot, or using hot water.

Do not use strong soaps or detergents for washing the motor home. Always use a mild soap in warm water, a commercially prepared product for cleaning automotive finishes or your local car wash. Be careful when using pressure-type washers to avoid loosening exterior decals or sealants, etc.

After washing the motor home, carefully inspect caulking around window frames and vents and any other joints that may have separated. Re-caulking, if necessary, is quite simple. Appropriate compounds are sold at Winnebago and Itasca dealers, and the materials are quickly and easily applied. Also, inspect weather seals around door, etc., and if necessary have a dealer replace them immediately.

CAUTION

Never use a strong solvent such as lacquer thinner, or harsh abrasives on painted surfaces.

Care of your Gelcoat Fiberglass Exterior

You can keep the gelcoated fiberglass exterior finish of your coach looking good for years to come with a minimum of care. The smooth automotive finish is as easy to care for as your car's - just wash regularly and wax as needed.

Washing

Regular washing with a soft brush, mild soapy solution and water will keep it clean - and keep black streaks from forming.

Waxing

A high-grade automotive wax used as needed will restore Performance Plus' original luster and color. It is best to wax at least every spring and fall, more often if your RV is frequently exposed to extreme sun, smog, soot or other environmental pollutants.



Stains and Discolorations

Regular cleaning and waxing will help prevent most discolorations and stains, however, please be aware that using caustic, highly alkaline cleaners or any cleaner with ammonia may actually darken your RV's exterior. If stains or discolorations do appear, they can be removed by gently wet-sanding the discolored area with a fine grit sandpaper and then using an electric or pneumatic buffer and a liberal amount of rubbing compound. Finishing with an automotive wax will restore the gelcoat's original luster.

NOTE: Your Winnebago Industries RV dealer is equipped and trained to handle this type of work. We advise you see him before attempting this yourself.

Scratches

Although the gelcoat exterior is very scratch resistant, scratches may occur occasionally. Those that haven't penetrated too deeply can usually be rubbed out with an automotive polishing compound applied with a power buffer or by hand. Not all scratches disappear completely, but they will be less noticeable. After using the polishing compound, you should then wax your RV to seal the surface. This will enhance the gelcoat's gloss and color and prevent stains. It is best to let your Winnebago Industries RV dealer evaluate the situation before using an automotive polishing compound.

If Accidents Happen, Repairs Are Easy

If a mishap causes a gouge or chip in your RV's gelcoat exterior, it can be repaired nearly anywhere, whether you are at home or on the road. Most Winnebago Industries RV dealerships have repair shops staffed with employees skilled in repairing gelcoat, or they can refer you to a body shop equipped to handle these repairs. Either way, your RV should come out looking like new.

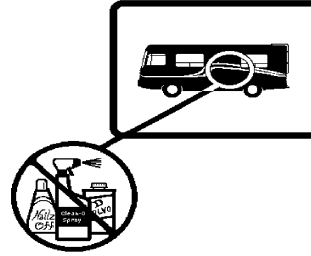

Care of Stripes and Decals

The pressure-sensitive decals on your coach require very little maintenance. They should be treated like any painted surface on your vehicle. Here are a few helpful hints on caring for decals:

- Wash decals with plain soap and water or any retail car wash soap. Always rinse thoroughly.
- Keep high-pressure wash nozzles at least 1 1/2 feet from edge of decals. High pressure water spray may cause edge lifting of decals.
- Test any cleaning solution on a small section of decal before using.



- Do Not use any aromatic solvents such as acetone, MEK, toluene, xylene, etc., on decals. Any solvent including alcohol may soften or smear colors.
- Do Not use lacquer thinner or paint on decals. Do Not overcoat decals with clear paint.
- Do Not let gasoline or other fuels drip and stay on decals for any length of time. Rinse immediately.



COMPARTMENT DOORS

Apply powdered graphite lubricant to compartment door latches periodically as necessary to keep latches operating smoothly.

If rubber door seals should become sticky, making the door hard to open, apply a rubber pro-



tectant such as 303™, Armor-All™, Son-of-a-Gun™, etc.

INTERIOR

UPHOLSTERY, CARPETING AND DRAPERIES

We recommend a weekly routine of vacuuming all fabrics and carpet throughout the motor home to prevent an accumulation of dirt which can detract from the appearance and shorten the life of carpet and fabrics.

Upholstery

Some fabrics used in this motor home may contain fire retardant and lightfastness additives which can be damaged by use of improper cleaning products. Some water-based household cleaning products are not formulated for use on fabrics and may cause excessive shrinkage or fading. Always test any cleaning product on a hidden area of fabric before using on visible areas. For best results, fabric cleaning should be referred to a professional carpet and upholstery cleaner.

NOTE: To minimize fading of upholstery, carpets and other interior fabrics caused by excessive sunlight, the drapes, blinds or shades should be closed when the motor home is parked for an extended period of time.

WARNING

When cleaning upholstery and fabric, do not use lacquer thinner, nail polish remover, laundry soaps, or bleach. Never use carbon tetrachloride, gasoline, or naphtha for any cleaning purpose. These materials may cause damage to the material being cleaned and most are highly flammable.

Spots and Stains

Spots or stains should be treated as soon as possible before they “set in” to avoid permanent damage. Always start from the outside of a spot or stain and work inward to avoid spreading it. Use a clean cloth or sponge and turn frequently to an unused area of the cloth or sponge as you clean.

Some stains or soils, such as lipstick, ink, grease or mustard, are extremely difficult or impossible to remove completely and should receive immediate attention. Consult a professional carpet and upholstery cleaner for assistance.

Vinyl Fabrics

Vinyl should be cleaned with a soft, damp cloth, and a mild detergent only. Do not use solvents. Solvents may damage the surface of the vinyl.

Leather Upholstery - Driver/Co-Pilot Seats & Sofa - (Optional)

The optional leather seats are made of top quality cattle hide soft leather.

- We recommend using a mild soap and water applied gently to the solid areas. Buff dry immediately with a soft cloth to avoid water spotting. Avoid harsh and excessive rubbing while cleaning. Soft leather needs delicate care.
- Never use harmful substances (e.g. stain removers, solvents, saddle soap, shoe polish or other unsuitable fluids) on soft leather. Cleaning and touch-up kits specifically formulated for leather upholstery are available from most fine furniture dealers.

Draperies, Curtains and Bedspreads

These items may be woven from a variety of fabrics. We recommend that these be professionally dry cleaned only. A five percent shrinkage may occur when you have these items dry cleaned.

Care of Ceiling Fabric

While using your coach, your ceiling fabric may become soiled and require spot cleaning from time-to-time. The following information is



provided as a guideline for care and cleaning of ceiling fabrics used in your coach. These materials are made from synthetic fibers, so they clean very well with virtually no damage to the color or fabric itself.

Most commercially available carpet and upholstery cleaners will do an excellent job removing stains. From time to time, additional cleaning methods may need to be used to remove stubborn or difficult stains.

General

As with any stain or contamination, the quick response is the best, especially when done in conjunction with the proper cleaner from the type of

stain. Important: Make sure you have selected the right cleaning agent from the list below from you begin the cleaning process.

NOTE: In many cases listed above, repeated steps may be required to fully extract the contaminant from the material. Use solvent-type cleaners in a well ventilated area.

NOTE: Always check to see that the cleaner will not cause damage to material or fabric by testing on a small area out of sight.

Type of Stain	Cleaning Agent	How to Remove
Mustard	Dry-Clean Solvent	Scrub-Soak-Blot Dry
Ketchup*	High-Strength Detergent	Scrub-Rinse-Blot Dry
Coffee*	High-Strength Detergent	Scrub-Rinse-Blot Dry
Chocolate*	Detergent	Scrub-Rinse-Blot Dry
Tea	High-Strength Detergent	Scrub-Rinse-Blot Dry
Chewing Gum	Dry-Clean Solvent	Scrub-Soak-Blot Dry
Oil	High Strength Detergent	Scrub-Soak-Blot Dry
Grease	High-Strength Detergent/ Degreaser	Scrub-Soak-Blot Dry
Tar/Asphalt	K-1 Kerosene/Thinner	Scrub-Soak-Blot Dry
Wax	Detergent	Hot Iron-On Detergent-Soaked Towel or Cloth
Rust	Rust Remover	Scrub-Rinse-Blot Dry
Dirt*	Detergent	Scrub-Rinse-Blot Dry
Lipstick	Dry-Clean Solvent	Soak-Blot Dry
Nail Polish	Dry-Clean Solvent	Soak-Blot Dry
Shoe Polish	Dry-Clean Solvent	Soak-Blot Dry
Crayon	High-Strength Detergent	Scrub-Rinse-Blot Dry
Marker (Indelible)	Detergent	Scrub-Rinse-Blot Dry
Ink (Ballpoint Pen)	Dry-Clean Solvent	Soak-Blot Dry
Pencil Lead (Graphite)	Detergent	Scrub-Rinse-Blot Dry
Vomit*	High-Strength Detergent	Scrub-Rinse-Blot Dry-Deodorize w/Vinegar
Urine*	High-Strength Detergent	Scrub-Rinse-Blot Dry-Deodorize w/Vinegar
Blood*	High-Strength Detergent	Scrub-Rinse-Blot Dry
Excrement*	High-Strength Detergent	Scrub-Rinse-Blot Dry-Deodorize w/Vinegar



NOTE: In many cases listed above, repeated steps may be required to fully extract contaminant from material. Items listed above with () may also be removed through steam extraction method by a professional cleaner or service.*

NOTE: Always check to see that the cleaner used will not cause damage to the material or fabric by testing on an area out of sight.

IMPORTANT: The recommendations made above are done in good faith and are based on a history of actual experiences and laboratory evaluations. Foss Manufacturing Company, Inc. and/or its designed distributor does not warrant, either expressed or implied, the effectiveness of the cleaning agents listed and the process for cleaning described above.

Water stains are the most common problem. The first thing to remember is that it's not the water itself that is making the stain, it is pigments the water extracts from the ceiling materials it travels through that causes the stain.

Mix 1/4 cup of white laundry detergent with a bucket of warm water. Working with a clean sponge or white cloth, start from the outside of the stain and work your way to the center. This method will keep the stain from spreading. Do not over saturate as this may cause delamination. No need to scrub, simply rub lightly or dab the stain.

You may have to repeat this procedure more than once to achieve desired results. Finish up with clean water, using the same method, and blot dry. REMEMBER, this is polypropylene, basic plastic, so do not be afraid to clean it.

Steam cleaning is also an option. Again, take care not to over saturate.

CABINETS

Wooden items may be cleaned with a soft cloth and a good quality wood finish cleaning product such as Guardsman™ or equivalent.

Vinyl simulated wood (Plus-Wood) panels may be cleaned with a mild, water based cleaner and a soft cloth. Do not use solvents on vinyl wood panels.

NOTE: Many cabinetry and furniture items throughout this motor home are constructed either partially or completely of real hardwoods. Because of natural variations in woodgrain density, slight differences in stain hue may exist between one item and another. This is the distinctive character and beauty of real wood.

Decorative Cabinet Mirrors and Windows

Use a good quality glass cleaner or mild soap and water solution. It is best to use a spray bottle to apply a light mist rather than saturating the surface. WIPE DRY IMMEDIATELY. DO NOT ALLOW GLASS TO REMAIN WETTED FOR LONGER THAN A FEW SECONDS. Prolonged moisture can cause the applique coating to lift from the surface of the glass.

Do not use sharp objects to scrape debris such as fly specks etc. Sharp objects can chip or lift the applique coating.

VINYL WALLBOARD

Decorative vinyl covered wallboards may be cleaned with a mild solution of water and isopropyl (rubbing) alcohol or a mild soap solution. Do not use solvents or abrasive cleaning products.

TABLES AND COUNTERTOPS

Table tops are covered with a plastic laminate material that resists solvents, stains and abrasions. A coat of furniture wax applied to these surfaces on the counters and table will help preserve their beauty and make cleaning easier. Always clean the surface before applying wax.

SOLID SURFACE GALLEY COUNTERTOP AND BATH LAVATORY

The galley countertop and lavatory surfaces are made of beautiful and durable simulated stone solid surface material.

- Wipe clean with a sponge and soapy water or ammonia-based cleaner.



- Stubborn stains may be removed using a 3M Scotch-Brite™ or equivalent type scouring pad.
- Towel dry to eliminate water spotting.
- Disinfect by wiping with 50/50 mixture of water and household bleach. Rinse with clear water.
- See the countertop manufacturer's Care & Maintenance booklet in your Owner's Info-Case for further information.

STAINLESS STEEL SINK

The stainless steel sink can be cleaned with soap or detergent. Rinse thoroughly with warm water and wipe dry to avoid streaks.

Use a mild abrasive for stubborn stains. Work in the direction of the polish lines. To keep the original finish, polish with a wax cleaner and rub with a dry soft cloth.

WARNING

Salts, mustard and mayonnaise may causing pitting. If spilled, clean immediately.



BATHROOM

The shower walls in the bathroom should be cleaned with a mild soap and water solution, or (to obtain maximum luster) use a good quality wax cleaner. Do not use an abrasive cleaner on the shower walls and tub. If the shower has a glass door, it is extremely important that abrasives not be used. Use only a good quality glass cleaner or mild detergent and water solution with a soft cloth to clean glass surfaces.

The bathroom lavatory is also a molded plastic material and should be cleaned with a mild soap and water solution. Abrasive cleaners or harsh detergents should not be used.

For instructions on the care of your fresh water toilet, refer to the information in your Info-Case.

DOORS AND WINDOWS

Windows may be periodically cleaned with a good quality glass cleaner or mild soap solution using a soft cloth. Use care when removing ice or frost from the windows. Always use a plastic ice scraper, never one made of metal. Use care when removing ice from the mirrors to protect the reflective surfaces.

Door locks and hinges should be lubricated periodically with powdered graphite to ensure trouble-free operation and to protect against freeze-up.



VEHICLE MAINTENANCE

(See also Safety Precautions, Section 1 of this manual).



CHASSIS SERVICE & MAINTENANCE

Consult the appropriate sections in your chassis operating guide for specific information regarding operating safety, service recommendations and maintenance schedules for the chassis section of your motor home.

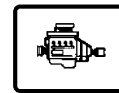

ENGINE ACCESS

FRONT ACCESS PANEL (HOOD)

Squeeze both latch handles behind both ends of lower edge of hood panel.

Swing the hood outward and down. Do not let hood drop.

To close the hood, lift and swing inward. Press to ensure the hood is locked closed.

With the hood open, the engine oil dipstick, oil fill, radiator fill, power steering reservoir and windshield washer reservoir are accessible. Some chassis also allow access to the engine air filter element.



See your chassis operator's manual for information and precautions on checking fluid levels, filling fluids and service information.

ENGINE COVER

Removal of the engine cover allows an authorized service technician access to the engine for scheduled service and maintenance.

- Insert the supplied hex wrench into the hole in the rear top edge of the engine cover.

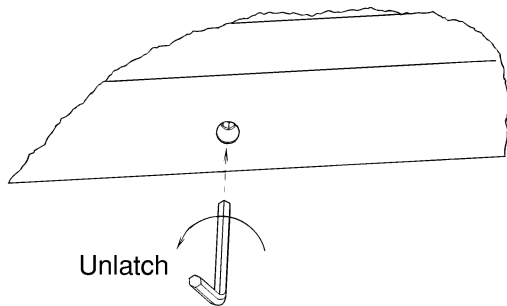

- Turn the hex wrench to the left (counter-clockwise) to unlatch.
- Lift the rear end of the cover upward and pull the cover from the opening.
- To return the cover, position the front end of the cover first, then lower the rear end. It is important to be sure the front edge is pushed completely forward to the radiator cover to ensure an air-tight seal.
- Press the rear end of the cover down and turn the hex wrench to the right (clockwise) until the latch pulls the cover downward and stops.



ENGINE COOLING SYSTEM

Refer to your chassis operating guide for information and precautions on filling, servicing and checking the fluid level.

CAUTION

When refilling the coolant system of a vehicle equipped with a rear auxiliary automotive heater and motoraid water heater, be sure to allow for additional coolant capacity of the heater and its supply and return hoses.



TIRES

Low air pressure results in tire overloading and abnormal wear and also affects handling and fuel economy. Obtain proper inflation pressures from your chassis operating guide or tire manufacturer.

WARNING

Make sure all replacement tires are of the same size and ply rating as those installed as original equipment.

See the Vehicle Certification Label affixed to the lower inside of the driver's door for tire information.



SUSPENSION ALIGNMENT AND TIRE BALANCE

The front suspension and steering system of this vehicle was factory aligned using highly accurate equipment prior to delivery to the dealership. However, we recommend that alignment be checked and adjusted, if necessary, after you have fully loaded the motor home according to your personal needs. Thereafter, the alignment should be periodically inspected to help prevent uneven tire wear.

Any excessive or abnormal tire wear may indicate worn or misaligned suspension or steering, unbalanced tire or other tire/suspension problem.

Alignment can be affected by worn steering/suspension parts or by incidents which happen



during driving, such as hitting a curb, pothole or railroad track, etc. Improper alignment can cause tires to roll at an angle and wear unevenly. It may also cause the vehicle to “pull” to the right or left. Have your dealer inspect your vehicle’s suspension and steering components periodically for misalignment or wear.

Out-of-balance tires will not roll smoothly and can lead to annoying vibrations and uneven tread wear such as cupping and flat spots. Tires may need to be balanced if uneven wear is detected or if ride comfort decreases noticeably.

See your chassis operating guide for further information.

Loading the Vehicle

NOTE: Your motor home’s load capacity is designated by weight, not by volume, so you cannot necessarily use all available space when loading your motor home. See page 4-1 for more information.



WINDSHIELD WASHERS AND WIPERS

See your chassis operating guide for recommendations and precautions regarding washers and wipers.



LIGHTS

All exterior lights should be checked for proper operation each time the vehicle is prepared for a trip. Any bulbs which fail to light should be checked and replaced, when necessary, with a new bulb of the same size. A failure of more than one light, such as both taillights not operating, may indicate a burned out fuse. Check fuse and replace with one of the same rating when necessary. If a fuse is not the cause of the problem, the wiring system should be checked immediately by an authorized service center.

The headlight circuit is protected by an auto reset circuit breaker built into the headlight switch. An overload on the breaker will cause the lights to flicker on and off. Headlight wiring should be checked immediately anytime this condition is apparent. Refer to your chassis operating guide for further information.

AUTOMOTIVE 12-VOLT FUSES AND CIRCUIT BREAKERS

The automotive fuses and breaker are conveniently located on the automotive fuse block below the left side of the dash (ahead of driver’s left foot).

The circuit breakers will pop outward if they are tripped. Simply push in to reset.

Always replace plug-in type fuses with those of the same amperage size.

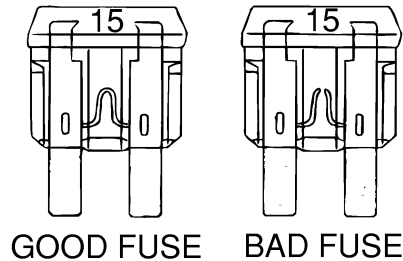

GOOD FUSE BAD FUSE

PLUG-IN FUSES





PREPARING VEHICLE FOR STORAGE

Properly preparing your vehicle for storage will lessen the possibility of damage to your vehicle. Prepare the motor home for vacancy just as you would if you were leaving your house for an extended period:

- Remove all perishables from cabinets and refrigerator
- Prop refrigerator door open.
- Turn off LP gas tank.
- Drain water heater, water tank and holding tank.
- Close shades to protect upholstery from sunlight

When storing your vehicle through the winter, or in cold climates, extra preparations need to be made to protect systems that can be damaged by freezing temperatures.



Cold Weather Storage Procedure (Winterizing)

1. Clean and dump holding tanks by following steps A, B, and C
 - A. Add water to the sewage holding tank by holding the toilet flush lever open with the water pump running. Add water to the waste water holding tanks by opening the kitchen, shower and lavatory faucets. Tanks should be about 1/4 to 1/3 full to rinse properly. Driving to a disposal site will normally loosen and rinse any waste material from the sides of the tank.
 - B. Completely drain the sewage and waste water holding tanks at an approved waste disposal site. Drain the sewage tank first so the following waste water can rinse any waste solids from the dump outlet and sewer hose.
 - C. Close dump valves and refit the dust cap onto the drain outlet.

2. Level the motor home and drain the entire plumbing system as described in the following steps.
3. Open all drain valves. (See the water system drain valve chart in section 7 for locations on your model.) Then turn on Wash Station Shower Head and lay shower head on ground to drain any water left in shower line. Also place the tip of your finger into the city water inlet and gently press the backflow valve "button" in the center of the inlet to drain any water left in the stub line.

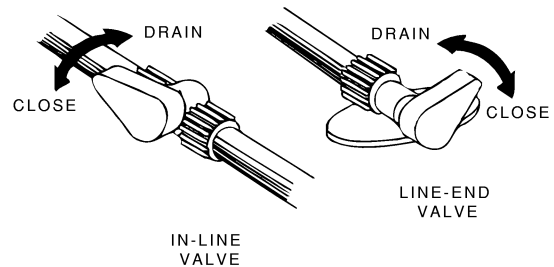

4. Remove and discard the water purifier filter cartridge:



Water Filter Assembly -
Below Galley Sink

- Raise the valve handle on the filter base.
- Twist the filter cartridge counterclockwise about a quarter-turn and pull it down and out of the filter base.

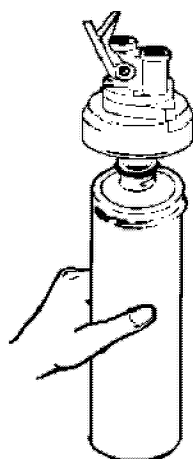

- Place a container beneath the filter base and lower the valve handle to drain any water remaining in the filter lines.
5. Install the antifreeze diverter plug:

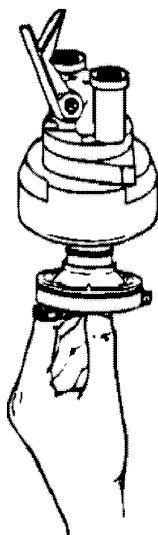

- Raise the valve handle on the filter base.
- Hold the diverter by the support bar as shown and guide it up into the center of the filter base with bar end approximately centered in colored ring cutout.
- Push the diverter up into the base as far as possible and turn it clockwise approximately a quarter-turn until it stops.
- Lower valve handle to lock the diverter plug in place.

NOTE: Before using again the following spring:

- Flush out the system with the diverter in place.
 - After the system has been thoroughly flushed, remove the diverter and store for future use. The diverter plug is intended for winterization only.
 - Install a new water filter cartridge.
 - If your coach is equipped with the refrigerator ice maker option, the ice maker water lines must also be drained. See "Winterizing the Ice Maker" in the refrigerator users guide in your InfoCase.
6. Turn the Water Pump switch ON to allow it to operate until you are done draining all faucets and toilet.
7. Open all faucets and shower head valves, including exterior shower.
8. Operate the toilet flush lever and hold until water stops flowing in the toilet. Then turn water pump switch OFF.
9. Turn off the water heater power switch before draining the water heater tank to avoid damage to the heating element. Drain the water heater by removing the plug from the base of the water heater tank, accessible from the outside of the coach. (Requires socket and ratchet.) Also open the Pressure-Temperature relief valve at the top right portion of the tank to prevent air locking in the tank while draining.



P-T Relief Valve

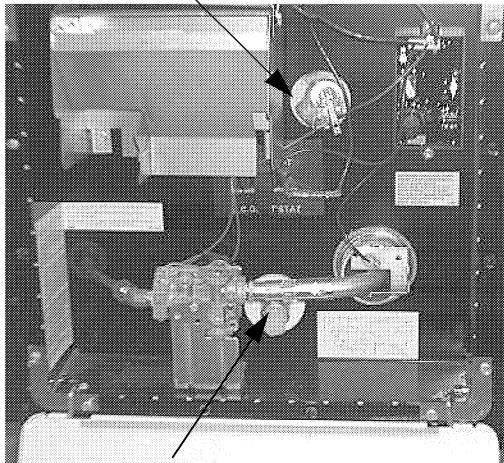

Water Heater Drain Plug
(Remove with Wrench)

10. After water has stopped draining at all faucets and drain valves, connect a “blow-out” plug to the city water connection on the coach. Then use a hand pump or air compressor regulated to 30 psi or less to force air through the system. (A “blow-out” plug can be purchased at any Winnebago or Itasca dealer. P/N 701705-01-000.)

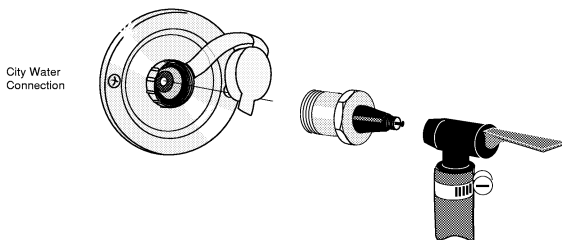

CAUTION

Limit air pressure to 30 psi to avoid damage to pump or water lines.

NOTE: *DO NOT burst air into the system. This can damage the water pump. It is better to let air in slowly.*

11. Let air flow for five minutes until water is completely drained out of faucets and drain valves. Then close faucets one at a time.

12. Operate and hold toilet flush lever until water is completely drained from toilet.

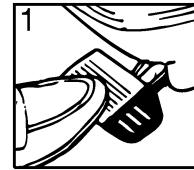

13. Now turn air pressure off and disconnect water purge adapters. Recap the city water connection to avoid contamination by dirt or insects.
14. Close all drain valves and faucets to avoid contamination by dirt or insects. Reinstall water heater drain plug and close P-T relief valve.
15. Pour about one cup of non-toxic RV antifreeze into the kitchen sink drain, bathroom sink drain and shower drain. This prevents any holding tank odors from entering the coach during storage.

WARNING

NEVER use automotive antifreeze/coolant in your RV water system. Auto antifreeze contains ethylene glycol which, if ingested, can cause blindness and can be fatal.

It is not necessary to add antifreeze to the toilet since the flush valve will be closed.

Do not add automotive antifreeze or caustic chemicals such as bleach or laundry detergents into the toilet bowl or holding tanks. Although these products may have a deodorizing effect, they may damage plastic and rubber parts in the system.

NOTE: *As an alternative to totally draining the plumbing system, you may winterize tanks and lines by pumping non-toxic RV antifreeze through the system. This product is available from your dealer and from most RV supply stores. Follow directions on the con-*



tainer to determine the correct amount to use for your coach.

See “RV Antifreeze Water Line Winterization Systems” on page 10-4 for instructions on filling with RV antifreeze.

If your coach is equipped with the optional water heater by-pass valve, you can fill the hot water lines with antifreeze solution without filling the water heater tank. See Section 8 for information on the by-pass valve.

CAUTION

Leave by-pass valve handle in NORMAL FLOW position if draining water and blowing out water lines. Place in BYPASS position ONLY when using antifreeze solution in water lines.

16. Place a bucket beneath the sewage drain valve outlet and re-drain the sewage and waste holding tanks of any clean water that entered during “blow-out” procedure.

Close dump valves to prevent valve shafts from rusting and to prevent entry by rodents and insects. Refit the dust cap onto the drain outlet.

Your drainage and fresh water systems are now totally winterized.

17. Have the vehicle chassis completely serviced and lubricated. Be sure radiator antifreeze protection level is sufficient for the lowest anticipated temperatures.
18. Wash and wax the coach.
19. Inspect all seams and seals around doors, windows, vents, and any other joints. Replace or repair any that are damaged. Sealing materials and compounds can be purchased from your dealer. Badly damaged weather seals may need to be replaced by your dealer.
20. Close all windows and roof vents. Protect all

appliance vent openings from contamination by animals or insects (e.g. bird nests, wasp nests, etc.)

21. Lubricate all door hinges and locks.
22. Clean the interior of the coach. Dirt and stains are more easily removed when fresh.
23. Remove all foods and items that may cause odors.
24. Clean and defrost the refrigerator. Leave the door slightly ajar to allow any odors to dissipate. Place an open box of baking soda inside the refrigerator to help absorb odors.
25. Turn the furnace thermostat switch on the bottom of the thermostat to OFF.
26. Turn auxiliary battery (Aux Batt) switch off. If your coach does not have an Aux Batt switch, disconnect all chassis and auxiliary battery cables.
27. Fully charge batteries. Batteries must have at least 80% charge to survive freezing temperatures and long periods of non-use.

NOTE: We do not recommend leaving the shoreline plugged in continuously during storage periods because the batteries can lose electrolytic fluids and become damaged from continuous charging without periodic use. We recommend following regular battery inspection and maintenance, especially in cold weather. See “Battery Maintenance” in Section 6.

RV ANTIFREEZE WATER LINE WINTERIZATION SYSTEMS

Manual Winterization Valve - Standard

Your coach is equipped with a manually operated water line winterization system for your convenience in winterizing fresh water lines.

The system features a diverter valve and suction tube in-line between the tank and water pump to draw non-toxic RV water system antifreeze into the water lines. This feature is located near the water pump and drain valves. See section 7 for location in your coach.

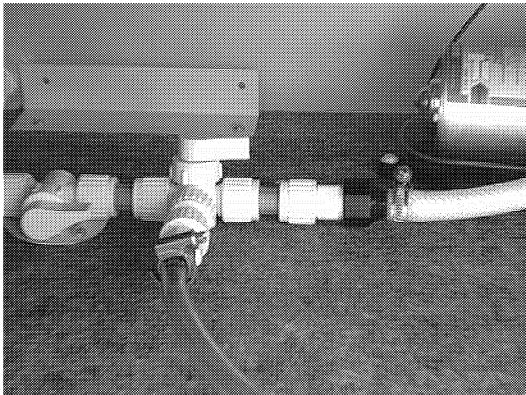

To Fill Lines with RV Water Line Antifreeze

- Turn water heater by-pass valve to BY-PASS position.
- Remove and save the protective cap from the end of the suction tube.
- Insert the end of the tube into a container of RV antifreeze solution.
- Turn the diverter valve handle so that it points toward the suction tube.
- Turn a water pump switch on.
- Open each cold water faucet handle in the coach one at a time until antifreeze solution just begins to flow from the faucet, then close.

When Done Adding RV Antifreeze:

- Turn water pump switch off.
- Turn the diverter valve handle so it points toward the water line to the pump as shown in the photo. This will stop the flow from the suction tube and revert the tank line flow to the pump.
- Replace the protective cap onto the end of the suction tube to keep out insects and debris when not in use.

Automatic Winterization System - Optional

Your coach may be optionally equipped with an electric pump powered automatic water line winterization system for your convenience in winterizing fresh water lines.

The siphon tube for the RV water system antifreeze is located on top of the LP tank compartment on the passenger side of the coach. Remove the large black plug and use a funnel to fill the tank. Capacity is approximately 2 gallons. The tank may require refilling before the system is completely filled.



The winterization system switch panel is located near the floor below the refrigerator.



- Press the bypass switch to avoid filling the 6 gallon water heater tank with antifreeze after draining the water heater at the service panel on the outside of the coach. If you should wish to fill the water heater tank with antifreeze solution, leave this switch off.
- Press the WINTERIZE switch to turn the winterizing pump system on to fill the lines with RV antifreeze solution.

Washer/Dryer Winterizing

1. Turn off the hot and cold water faucets to the machine and disconnect the hoses. (Tie or wire up the hoses to the faucets to keep them from dropping down behind the machine.)
2. Set the machine to fill on regular cycle and WARM wash.
3. Turn the machine On for a few minutes so it can take in any water left in the hoses. (Lift the hoses at this time to be sure no water is



- trapped in low spots of the hose.)
4. Turn the machine Off.
 5. Advance the wash time to SPIN cycle and turn the machine On to pump out as much water as possible.
 6. Turn the machine Off again.
 7. Place a bath towel or shallow container beneath the drain/lint filter door on the lower front of the machine to catch water. Then remove the filter to drain any water left in the bottom of the machine.
 8. Reinstall the filter correctly to assure that it does not leak water.
 9. Optional - If you wish to add RV antifreeze to ensure safety of the washer pump, add about a gallon of non-toxic RV water system antifreeze to the washer drum and rerun the SPIN cycle to fill the pump and lower cavities with the solution.
 10. Turn the machine Off. Washer winterizing is now complete.

NOTE: Remember to reconnect the washer supply hoses when placing the coach back into service.

8. Check sealing valve in the toilet for proper operation and lubricate with silicone spray.
9. Add water to the holding tank using the toilet flush pedal. Check to be sure dump valve seals tightly.
10. Check around all appliances for obstructions and ensure that all vent openings are clear.
11. Start refrigerator and check for proper cooling.
12. Clean paneling and counter surfaces and apply a thin coat of wax.
13. Replace batteries if necessary and check out electrical system to make sure all lights and electrical components operate.
14. Check tires for proper cold inflation pressure.
15. After washing accumulated winter grime from the vehicle, it is important to carefully inspect the seams and sealants for separation or cracks that may have appeared around the window frames, vents and any other joints. Re-sealing is quite simple and the material is quickly and easily applied. Appropriate compounds are available from your dealer. Also inspect weather seals around doors, etc., and if necessary, have a dealer replace immediately.



REMOVAL FROM STORAGE

1. Completely air out the motor home.
2. Have the entire LP gas system checked for leaks.
3. Check window operation.
4. Check cabinet and door hinges. Lubricate with penetrating oil, if necessary.
5. Close all faucets and drain valves that are open. If necessary, reconnect toilet water line and close flush valve.
6. Add a few gallons of water to the fresh water tank and check for leaks especially at junctions. Also make sure all hangers and supports are securely in place. Sanitize the water system as outlined under "Disinfecting the Fresh Water System" in Section 7.
7. Check operation of all faucets to be sure faucet washers have not hardened during storage.

A	
Accumulator Tank	7-3
Air Conditioner, Automotive (Dash)	2-14
Air Conditioning, Central "TrueAir"	8-14
Alarm, Carbon Monoxide	1-6
Alarm, LP Gas	1-3
Alarm, Smoke	1-7
Alignment, Front Axle Tire	4-1
Alignment, Suspension and Tire Balance	9-7
Amplifier, Antenna Signal	8-16
Antenna, CB SWR Adjustment	2-17
Antenna Check Light	8-16
Antenna, TV	8-15
Antenna Signal Amplifier	8-16
Antifreeze, RV Winterization Systems	10-4
Automatic Power Transfer Switch (Generator)	6-6
Automatic Winterizing System	10-5
Auto 12V Fuses & Circuit Breakers	6-8, 9-8
Auxiliary Battery Switch	2-16
Aux Coach Heater	2-14
Aux Start Switch	2-15
Auxiliary (House) Batteries	6-8
Auxiliary 110-Volt Generator	6-5
B	
Bathroom, Care of	9-6
Batteries, Chassis (Starting)	6-8
Batteries, Auxiliary (House)	6-8
Battery Charger, Connecting	3-4
Battery Voltage Meter	8-8
Battery Information	6-8
Battery Maintenance	6-10
Battery Switch, Aux	2-16
Beds, Converting for use	8-19
Before Driving your Vehicle	2-1
Before Entering your Vehicle	2-1
Black Water Holding Tank Flushing	7-6
Brake, Parking	2-2
By-Pass Valve, Water Heater	8-11
C	
Cabinets	9-5
Cable TV Hook-Ups	8-17
Campsite Selection	4-6
Capacities* Fuel Tank*	2-2
Fresh Water Tank*	7-1
Holding Tanks*	7-6
Water Heater*	8-8
Carbon Monoxide Alarm	1-6
Carbon Monoxide Warning	1-5
Carpets, Care of	9-3
CB Antenna, SWR Adjustment	2-17
CB Radio Wiring	2-16
Charger Panel, Solar (Optional)	6-8
Charging Section	6-3
Chassis Operating Guide	0-1
Chassis Service and Maintenance	9-6
Check Light, Antenna	8-16
Checklist, Pre-Travel	4-3
Child Restraints	2-8
Circuit Breakers, 12-Volt	6-7, 9-7
Circuit Breakers, 110-Volt	6-3
City Water Hook-Up	7-3
Coach Heater, Aux	2-14
Coach Leveling System	2-17
Cold Weather Storage (Winterizing)	10-1
Comfort Controls	2-13
Compact Disc (CD) Changer	2-15
Condensation, Humidity and	4-7
Connecting a Battery Charger	3-4
Connecting the Shoreline	6-2
Control Center, Video Selection	8-17
Converter, Electrical Power	6-3
Converter Overload Protector	6-4
Cooling System, Engine	9-7
Couch/Bed Conversion	8-19
Crank-Out Windows	8-24
Cruise Control	2-13
D	
Day/Night Pleated Shades	8-24
Decals and Stripes	9-2
Defects, Reporting Safety	0-2
Defroster	2-14
Deluxe Sound System	2-15
Dinette/Bed Conversion	8-19
Disinfection of Fresh Water Tank	7-4
Door Handles and Locks	2-3
Doors and Windows, Care of	9-3
Door Locks, Entrance	2-3
Drain Valves, Water	7-9
Drainage System, Waste Water	7-6
Draperies, Care of	9-3

INDEX

Drinking and Driving.....	0-2	Generator Hourmeter	6-7
Driver Seat	2-6	Ground Fault Circuit Interrupter.....	6-5
Driving Safety Precautions	1-1		
Dual Rear Wheels	3-2	H	
Dumping Holding Tanks	7-6	Hazard Warning Flashers.....	3-1
		Heat Pump.....	8-13
E		Heater, Automotive (Dash).....	2-14
Effects of Prolonged Occupancy	4-7	Holding Tank Level Indicators	8-7
Electrical Outlets, 110-volt.....	6-5	Hourmeter, Generator	6-7
Electrical Safety Precautions	1-4	Humidity and Condensation	4-7
Electrical System, 110-volt AC	6-1		
Electrical System, 12-volt DC	6-7	I	
Emergency Crank-In, Slide-Out Room.....	2-20	Instrument Panel	2-12
Emergency Exits.....	1-6	Interior Care.....	9-3
Energy Management System, PowerLine.....	6-2		
Engine Access.....	9-6	J	
Engine Cooling System	9-7	Jump Starting	3-3
Engine Overheat.....	3-4		
Entertainment Center, Exterior	8-18	K	
Entrance Door Lock and Handle.....	2-3	Keys	2-3
Entrance Steps, Electric Powered	2-4		
Equipment, Options and	0-2	L	
Exits, Emergency	1-6	Leather Upholstery	9-3
Extending Slide-Out Room.....	2-18	Leveling, Coach	2-17, 4-6
Exterior Body Care	9-1	Leveling System, Coach	2-17
Exterior Entertainment Center	8-18	Lights	9-8
Exterior Features.....	0-5	Loading, Roof	4-2
Exterior Shower	7-5	Loading the Vehicle	4-1
External (City Water) Connector.....	7-3	LP Gas Alarm	1-3
External Power Cord (Shoreline).....	6-1	LP Gas Furnace	8-12
		LP Gas Leaks	1-3, 5-4
F		LP Gas Level	8-8
Filling the Fuel Tank.....	2-2	LP Gas Pressure Regulator	5-3
Fire Extinguisher	1-6	LP Gas Safety	5-1
Flushing Black Water Holding Tank	7-6	LP Gas Selection.....	5-2
Formaldehyde Warning	1-5	LP Gas Tank, Air in the	5-3
Fresh Water Tank.....	7-1	LP Gas Tank, Refilling	5-3
Disinfection of	7-4	LP Gas Tank System.....	5-2
Drain	7-9	LP Gas, Travel with	5-3
Filling	7-1	LP Gas, Winter Use of	5-5
Fresh Water Toilet	8-23	Luggage Compartment Doors.....	2-5
Front Axle Tire Alignment	4-1		
Fuel Selection	2-2	M	
Fuel Tank Capacity	2-2	Maximum Occupancy.....	4-2
Fuel Tank, Filling	2-2	Microwave Oven.....	8-6
Furnace, LP Gas	8-12	Mirrors, Power Electric	2-9
		Monitor, Rearview TV.....	2-9
G		Monitor Panel, OnePlace	8-7
Gas Alarm, LP	1-3	Motor Aid Water Heater.....	8-11
Gas Leaks, LP	1-2, 5-4	Mountain Driving	4-5
General Warnings	1-1		
Generator, Auxiliary 110-Volt	6-5		

N	
Nighttime Driving	4-5
O	
Occupancy, Effects of Prolonged	4-7
Occupancy, Maximum	4-2
OnePlace Systems Monitor	8-7
Operating the Oven	8-6
Operators Manual	0-1
Options and Equipment	0-2
Outlets, 110-Volt	6-5
Overload Protector, Converter	6-4
P	
Parking Brake	2-2
Phone Input Connection	8-17
Pilot, Lighting Oven	8-6
Pleated Shades, Day/Night	8-24
Power Converter System	6-3
Power Electric Mirrors	2-9
PowerLine Energy Management System	6-2
Power Bath Vent	8-24
Power Seat, Driver Six-Way	2-6
Power Step, Entrance	2-4
Pre-Travel Checklist	4-3
Preparing Vehicle for Storage	10-1
Pressure Regulator, LP Gas	5-3
Prolonged Occupancy, Effects of	4-7
Pump Switch, Water	7-2
R	
Radio Switch	2-14
Radio Wiring, CB	2-16
Range Hood	8-6
Rearview TV Monitor	2-9
Recovery Towing	3-3
Refrigerators	8-1 - 8-5
Regulator, LP Gas	5-3
Relief Valve, Water Heater	8-10
Removal from Storage	10-5
Reporting Safety Defects	0-2
Restraints, Child	2-8
Retracting Slide-Out Room	2-19
Roof Loading	4-2
Roof Maintenance	9-1
RV Antifreeze Winterization Systems	10-4
S	
Safe Use of LP Gas System	5-1
Safety Defects, Reporting	0-2
Safety Precautions	1-1 - 1-6, 3-2
Satellite TV System - Optional	8-18
Seat, Driver	2-6
Seat Belts and Child Restraints	2-7, 2-8
Seats	2-5
Selecting Fuel Types, LP	5-2
Service Assistance	0-2
Severe Weather Information	4-4
Sewer Hook-Ups, Using On-Site	7-7
Shades, Day/Night Pleated	8-24
Shoreline, Connecting the	6-1
Shower, Exterior	7-5
Shower Hose Vacuum Breaker	7-5
Signal Amplifier, TV Antenna	8-16
Sink, Stainless Steel	9-4
Sleeping Facilities	8-19
Slider Windows	8-24
Slideout Rooms	2-18
Emergency Crank-In	2-20
Extending Room	2-18
Retracting Room	2-19
Travel Straps	2-18
Solar Charger Panel (Optional)	6-8
Sound Systems	2-14
Speed Control (Cruise)	2-13
Spots and Stains	9-3
Start Switch, Aux	2-15
Starting and Stopping the Engine	2-2
Step, Electric Power Entrance	2-4
Storage, Preparing Vehicle for	10-1
Storage, Removal from	10-5
Stripes and Decals	9-2
Suspension Alignment and Tire Balance	9-7
Switch, Radio	2-14
SWR Adjustment, CB Antenna	2-17
T	
Table and Countertop Surfaces	9-5
Tank, Fresh Water Filling	7-1
Tank Capacities, Water and Holding	7-9
Telephone Hook-Ups	8-17
Thermostat, Electronic - Furnace	8-12
Tire Alignment, Front Axle	4-1
Tire Balance, Suspension Alignment and	9-7
Tire Changing	3-2
Tires	9-7
Toilet, Fresh Water	8-23
Towing, Recovery	3-3
Trailer Towing	4-2
Trailer Wiring Connector	6-11
Travel Straps, Slide-Out Room	2-18
Travel Tips	4-3
Travel with LP Gas	5-3
TrueAir Central Air Conditioning	8-14

INDEX

TV Antenna.....	8-15	Windshield Wiper/Washer Switch.....	2-13
TV & Cable Hook-Ups,	8-17	Winter Use of LP Gas	5-5
TV Signal Amplifier	8-16	Winterization Systems, RV Antifreeze.....	10-4
TV Monitor, Rearview (Backup Monitor).....	2-9	Winterizing	10-1 - 10-5
U			
Underbody Care	9-1	Wiring, CB Radio	2-16
Upholstery, Care Of	9-3	Wiring, Trailer Connector.....	6-11
Using On-Site Sewer Hook-Ups.....	7-7		
V			
Vehicle Certification Label (VIN).....	0-4		
Vehicle Maintenance	9-6		
Vents, Bath.....	8-24		
Video Selection System	8-17		
Vinyl Fabrics	9-3		
Vinyl Wallboard	9-5		
W			
Warnings:			
Carbon Monoxide	1-5		
Driving	1-1		
Formaldehyde	1-5		
Fuel & LP Gas	1-2		
LP Gas Leaks	1-2		
LP Gas Alarm	1-3		
Electrical	1-4		
Loading	1-4		
Maintenance.....	1-5		
Warranty	0-2		
Water and Holding Tank Levels	8-7		
Water Drain Valves	7-9		
Water Heater, Motor Aid	8-11		
Water Heater	8-8		
Water Heater By-Pass Valve	8-11		
Water Heater Capacity.....	8-8		
Water Line Drain Valves	7-9		
Water Pump	7-2		
Water Pump Switch	8-8		
Water Purifier System.....	7-5		
Water Tank, Disinfection of	7-4		
Water Tank Filling	7-1		
Weighing Your Loaded Vehicle.....	4-1		
Wheels, Rear Dual	3-2		
Wheel Nuts	3-3		
Windows, Cleaning	9-6		
Windows, Crank-Out	8-24		
Window Shades, Pleated.....	8-24		
Windows, Slider	8-24		
Windows and Doors	8-20, 9-6		
Windows, Emergency Exit	1-6		
Windshield Washers and Wipers.....	9-8		

IMPORTANT SERIAL NUMBERS

Motor Home (Coach): Year _____ Model _____ Serial _____

Chassis: Make _____ Serial (VIN) _____

Air Conditioner: Brand _____ Model _____ Serial _____

Furnace: Brand _____ Model _____ Serial _____

Water Heater: Brand _____ Model _____ Serial _____

Power Converter: Brand _____ Model _____ Serial _____

110-Volt Generator: Brand _____ Model _____ Serial _____

Range Brand _____ Model _____ Serial _____

Microwave Oven: Brand _____ Model _____ Serial _____

Refrigerator Brand _____ Model _____ Serial _____

Television: Brand _____ Model _____ Serial _____

Video Cassette Player: Brand _____ Model _____ Serial _____

EMERGENCY INFORMATION

Dealer

Name _____

Address _____

Phone _____

INSURANCE POLICY

Company _____

Policy Number _____

Phone _____

